

Name

Q - BIC A 380X380; 44

Zeichnung/Drawing

3D

Profil/Profile

4.4X13.5

Datum/Date

18.05.2023

2100

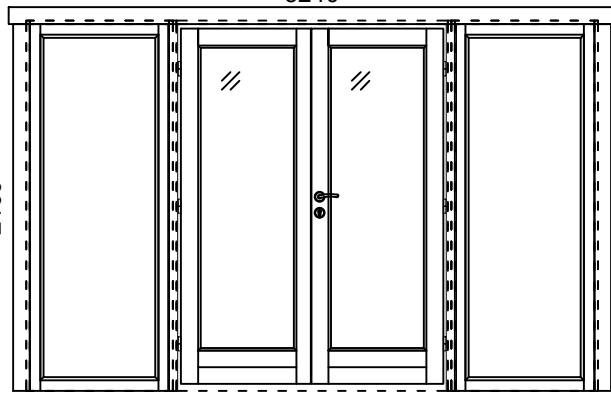

W126-FT

D202-RT

W126-FT

EL29-Q5

3240

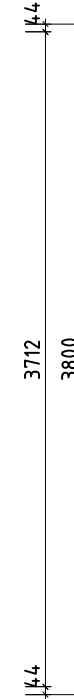
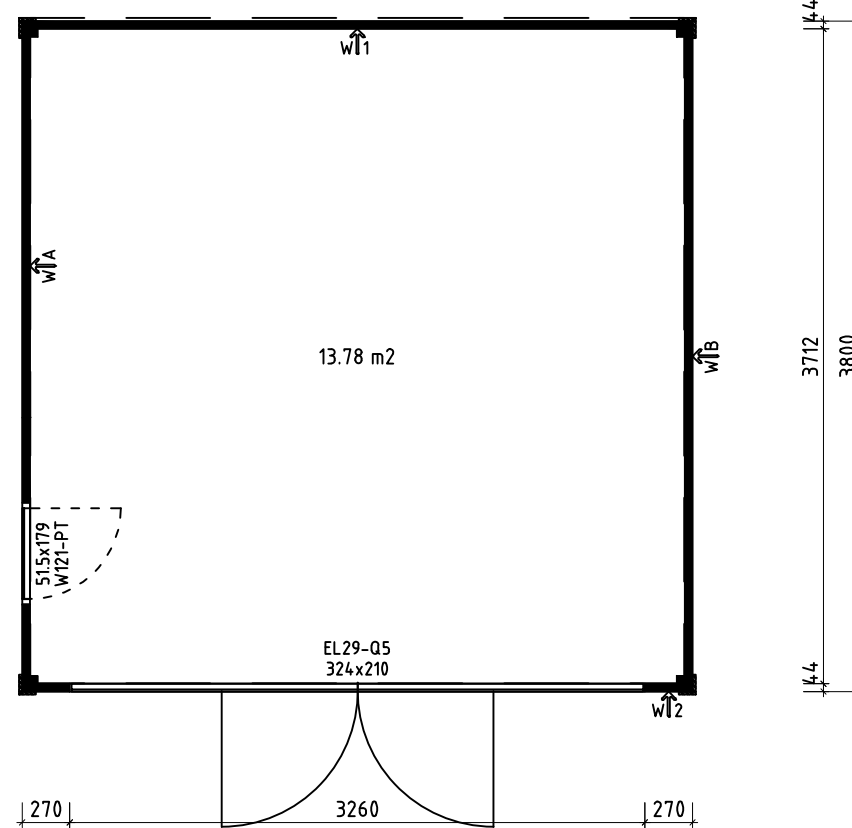
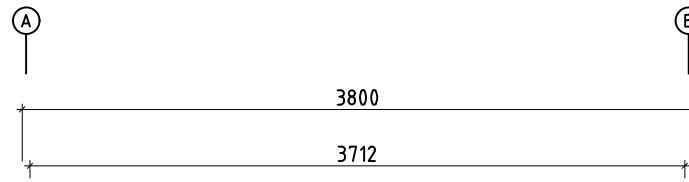

* Fenster und Türen sind ohne Sprossen
Windows and doors are without muntins

Q5 - Qualitätsklasse für Fenster und Türen/
Quality class for windows and doors

Name	Q - BIC A 380x380; 44	
Zeichnung/Drawing	Grundplan, Plan	
Profil/Profile	4.4x13.5	Datum/Date 18.05.2023

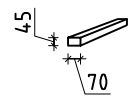
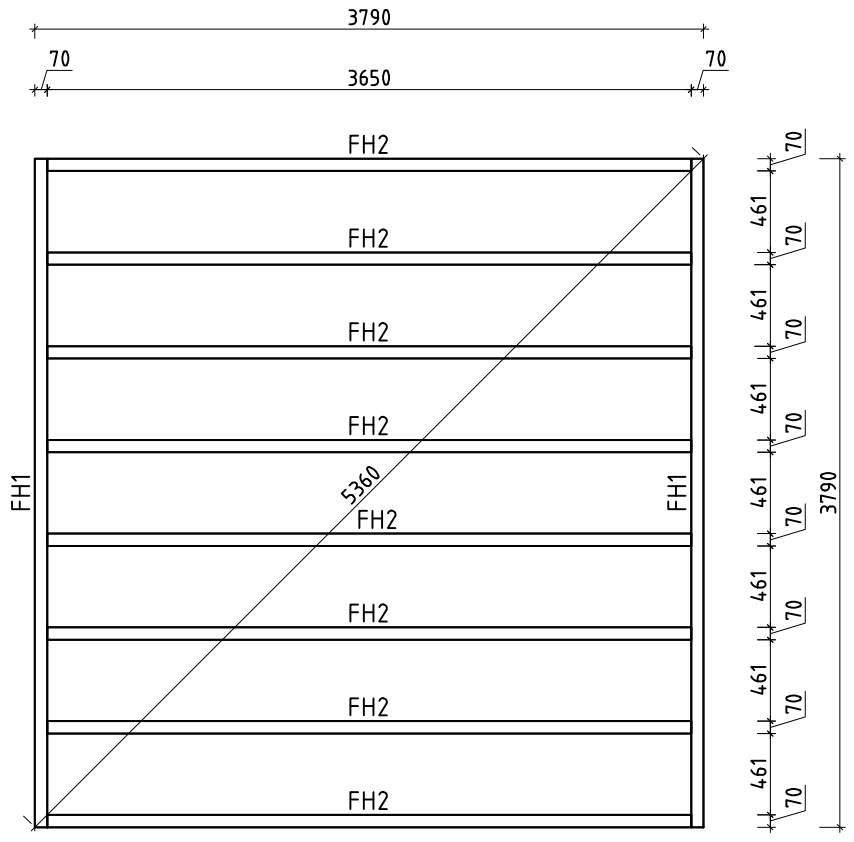



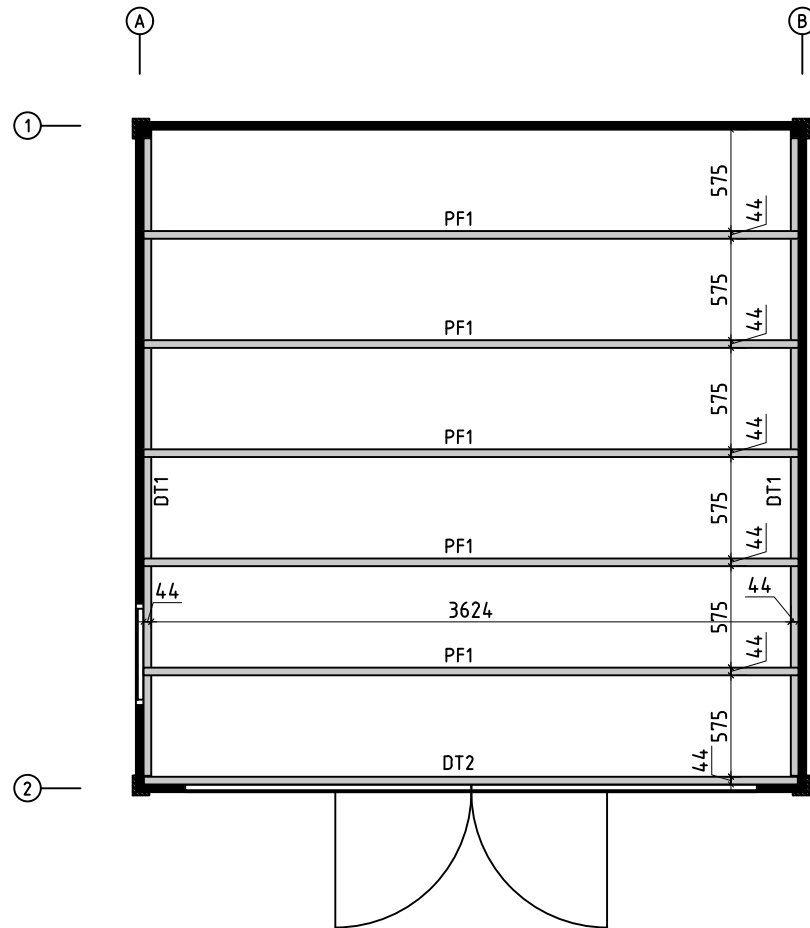



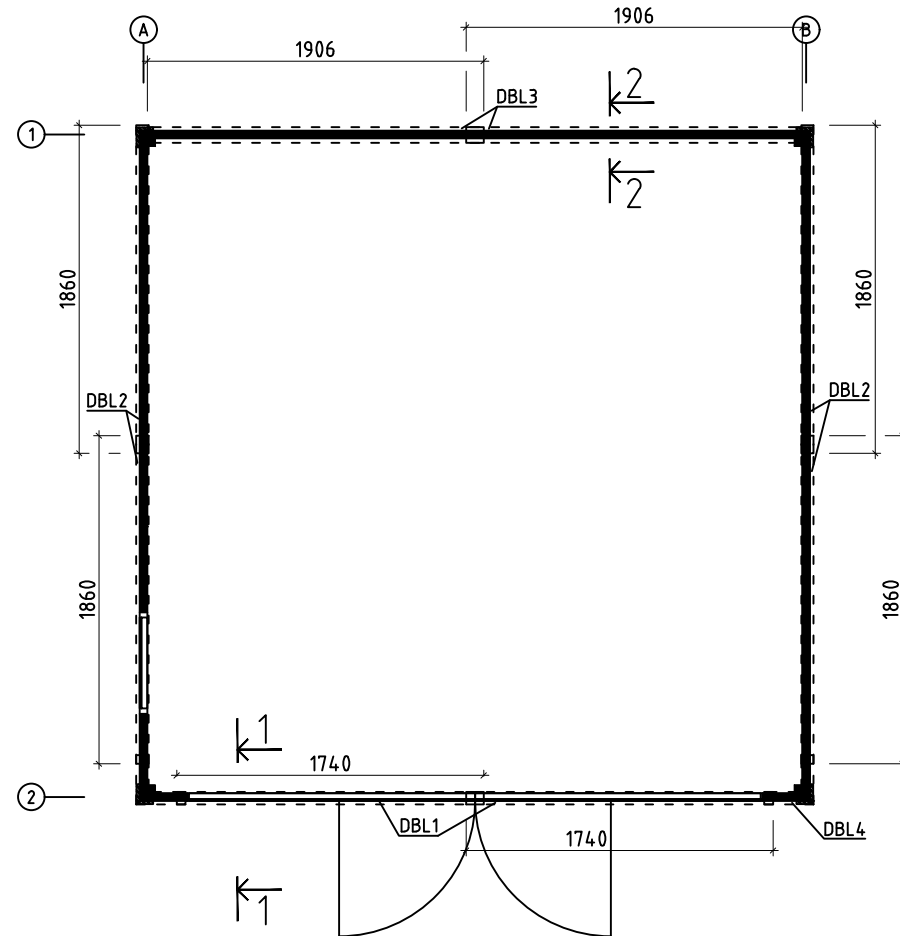



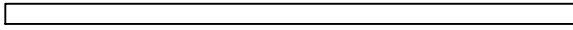
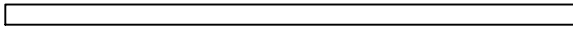
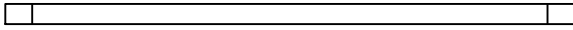
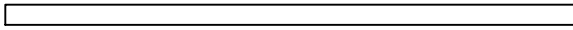
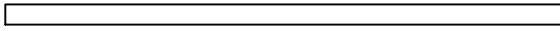
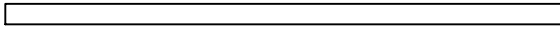
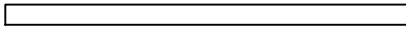



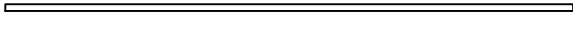

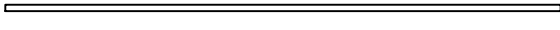



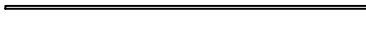

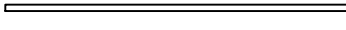
Name	Q - BIC A 380x380; 44	
Zeichnung/Drawing	Lagerholzplan, Foundation beams	
Profil/Profile	4.4x13.5	Datum/Date 18.05.2023

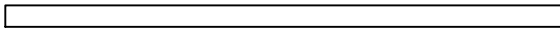

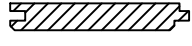
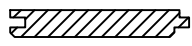





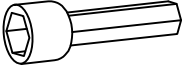
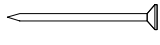

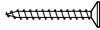
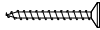
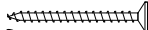
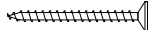
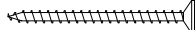
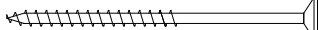
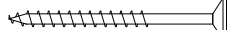
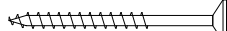
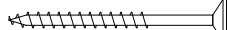
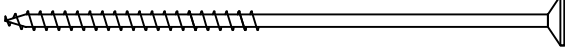

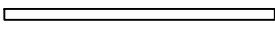
Name	Q - BIC A 380x380; 44		
Zeichnung/Drawing	Pfetten, Deckenträger; Purlins, Cover carriers		
Profil/Profile	4.4x13.5	Datum/Date	18.05.2023

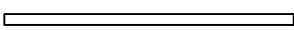

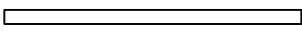
Name	Q - BIC A 380x380; 44	
Zeichnung/Drawing	Blech für Dachabschluss, Sheet metal for roof	
Profil/Profile	4.4x13.5	Datum/Date 18.05.2023

Pos	Teileliste/Specification Q - BIC A 380x380; 44	Stck Pcs.	Profil Profile (mm)	Länge Length (mm)
000	 Extra log	1	44x135	3800
001		2	44x135	3800
002		1	44x135	3800
003		16	44x135	3800
004		2	44x135	3712
005		20	44x135	3712
006		14	44x135	2687
007		14	44x135	450
008		24	44x135	270
009		8	44x135	270
FH1	FUNDAMENTHOLZ (imprägniert) - FOUNDATION BEAM (impregnated) 	2	70x45	3790
FH2	FUNDAMENTHOLZ (imprägniert) - FOUNDATION BEAM (impregnated) 	8	70x45	3650
DT2	DECKENTRÄGER - COVER CARRIER  	1	44x44	3707
DT1	DECKENTRÄGER - COVER CARRIER  	2	44x44	3614
LE1	LEISTE - LATH   ✓	8	95x18	2430
LT1	LATTEN - STUDS  	4	44x44	2295
PF1	PFETTEN - PURLINS  	5	44x145	3712
	DACHBRETTER - ROOF BOARDS 	33+1	113x18	3772
	FUSSBODENBRETTER - FLOOR BOARDS 	33+1	113x18	3707
	FUSSBODENLEISTEN - FLOOR STRIPS  ✓		18x40	17.0 lfm/rm
DPL-1	DACHPAPPENLEISTEN - ROOFING FELT STRIPS 15x28  ✓		15x28	12.0 lfm/rm
SH	SCHLAGHÖLZER - MOUNTING PIECES 	3		
ML1	Metallstange - Metal bar 	6	D10	900
SR50	Blechschauben mit Dichtung - Tapping screw with seal 	46		
T001	Innensechskant Bit für Blechschauben - Tek screw adapter 	1		
NG2 550	NÄGEL - NAILS 2.5x50 Dachbretter - Roof boards 	462		
Kood	Q - BIC A 380x380; 44	Materjal		Leht 1/3

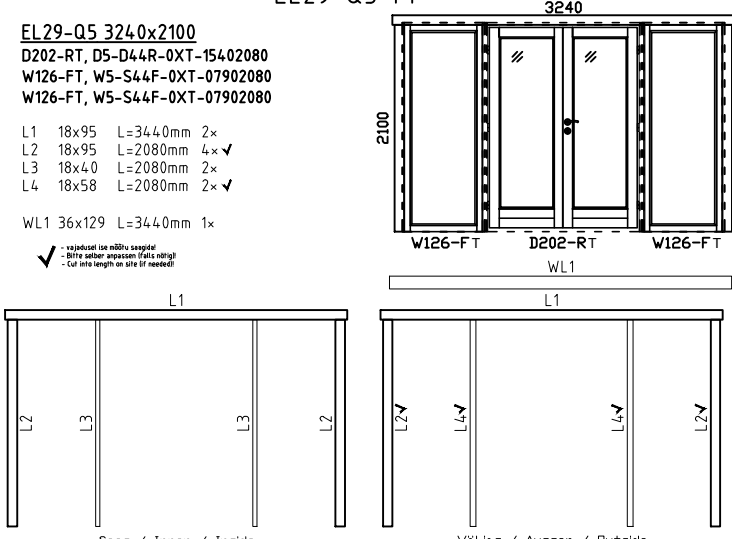
Pos	Teieliste/Specification Q - BIC A 380x380; 44	Stck Pcs.	Profil Profile (mm)	Länge Length (mm)
NG2 550	NÄGEL - NAILS 2.5x50 Fussbodenbretter - Floor boards 	528		
SR3 030	Schrauben - Screws 3.0x30 Dachpappeleiten - Roofing felt 	24		
SR3 030	Schrauben - Screws 3.0x30 Fussbodenleisten - Floor strips 	30		
SR37	Schrauben - Screws 3.5x45 Tür/Fensterleisten - Door/Window strips 	104		
SR3 545	Schrauben - Screws 3.5x45 Leiste - Lath 	80		
SR44	Schrauben - Screws 4.0x60 Wasserleiste - Rain strip 	8		
SR5 0100	Schrauben - Screws 5.0x100 Fundamenthölzer - Foundation beams 	40		
SR5 070	Schrauben - Screws 5.0x70 Deckenträger - Cover Carrier 	37		
SR5 070	Schrauben - Screws 5.0x70 Pfetten - Purlins 	20		
SR5 070	Schrauben - Screws 5.0x70 Wandbalken zum Eckpfoste - Wallbeams to corner post 	272		
SR6 0180	Schrauben - Screws 6.0x180 Pos - Log 001, 004 	18		
TST	Türstopper - Doorstop 	1		
DBL1	 Blech für Dachabschluss 	2		1740
DBL2	 Blech für Dachabschluss 	4		1860
DBL3	 Blech für Dachabschluss 	2		1906
DBL4	 Blech für Dachabschluss 	2		280+280
	<p>FENSTER/WINDOW 3240x2100 Q5 EL29-Q5 44</p> <p>EL29-Q5 3240x2100 D202-RT, D5-D44R-0XT-15402080 W126-FT, W5-S44F-0XT-07902080 W126-FT, W5-S44F-0XT-07902080</p> <p>L1 18x95 L=3440mm 2x L2 18x95 L=2080mm 4x ✓ L3 18x40 L=2080mm 2x L4 18x58 L=2080mm 2x ✓</p> <p>WL1 36x129 L=3440mm 1x</p> <p>✓ - vajadusel ise mõnu saagide - Bitsi seiber anpassen (falls nötig) - Cut into length on site if needed!</p> 	1		
Kood	Q - BIC A 380x380; 44	Materjal	Leht	2/3

1-1

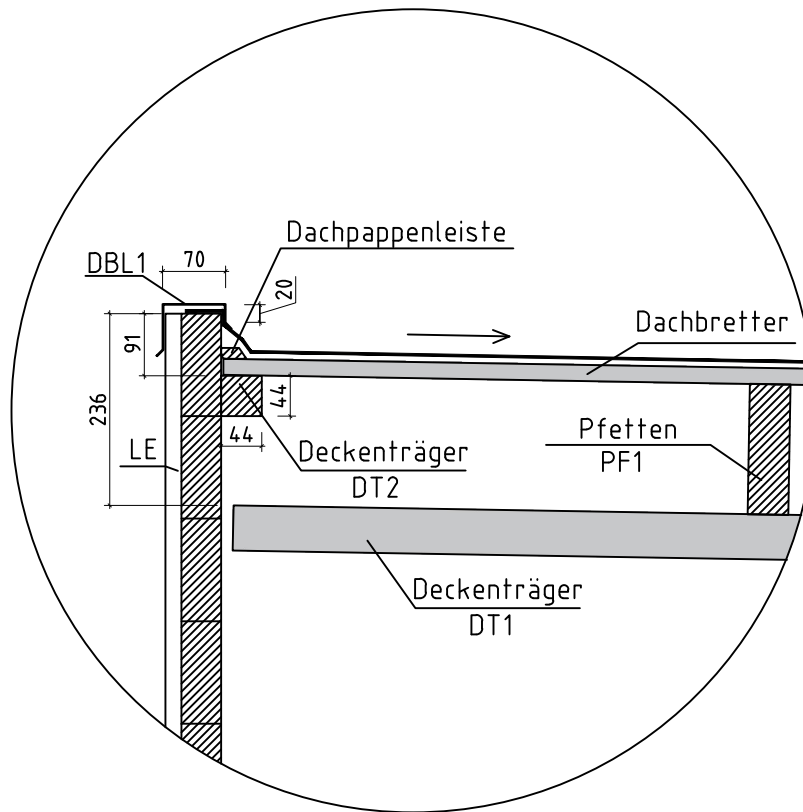

2-2

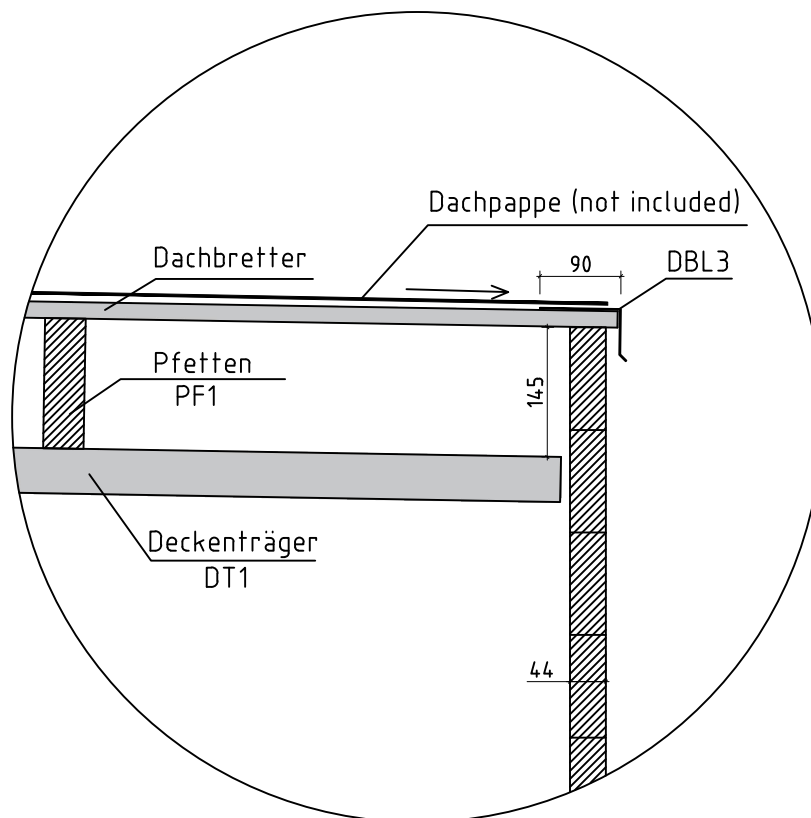

Name	Q - BIC A 380x380; 44	
Zeichnung/Drawing	Abbildzeichnungen (Schnitte), Section drawings	
Profil/Profile	4.4x13.5	Datum/Date 18.05.2023

Q5

EL29-Q5 3240x2100

D202-RT, D5-D44R-0XT-15402080

W126-FT, W5-S44F-0XT-07902080

W126-FT, W5-S44F-0XT-07902080

L1	18x95	L=3440mm	2x
L2	18x95	L=2080mm	4x ✓
L3	18x40	L=2080mm	2x
L4	18x58	L=2080mm	2x ✓

WL1 36x129 L=3440mm 1x

- ✓ - vajadusel lise mõju saagidal
- Bitte selber anpassen (falls nötig)!
- Cut into length on site (if needed)!

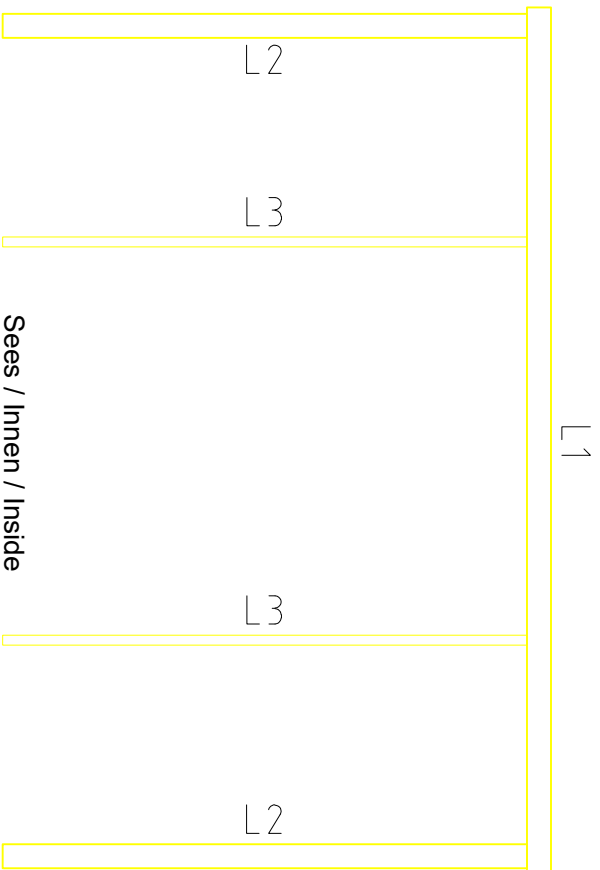

Sees / Innen / Inside

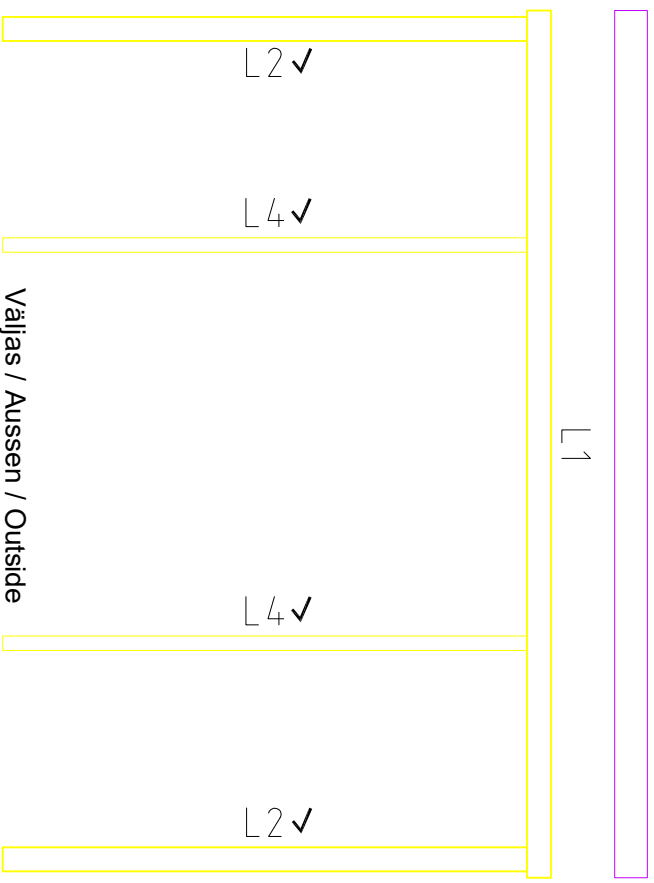
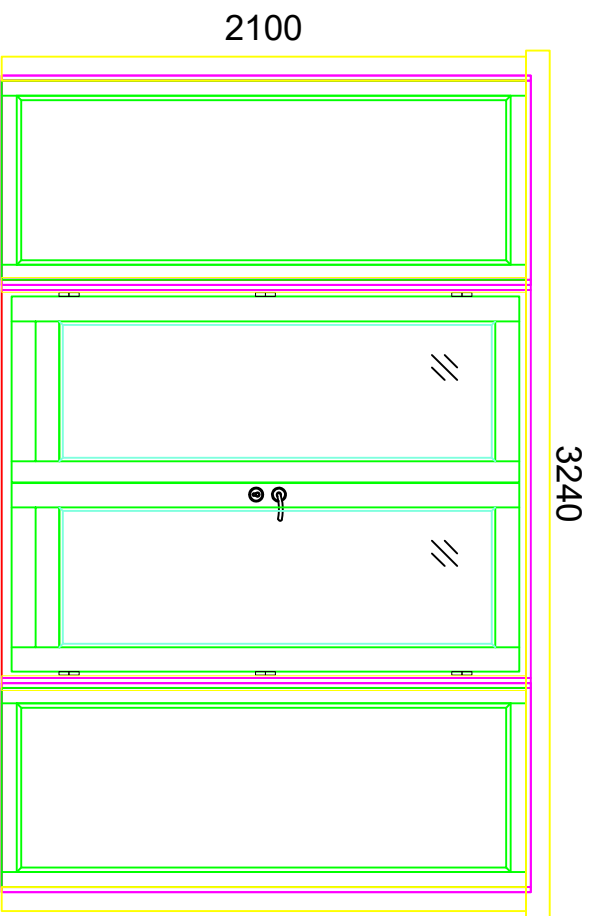

Väljas / Aussen / Outside

Q5

EL29-Q5 3240x2100

Vaade väljast

Blick von Aussen

View from outside

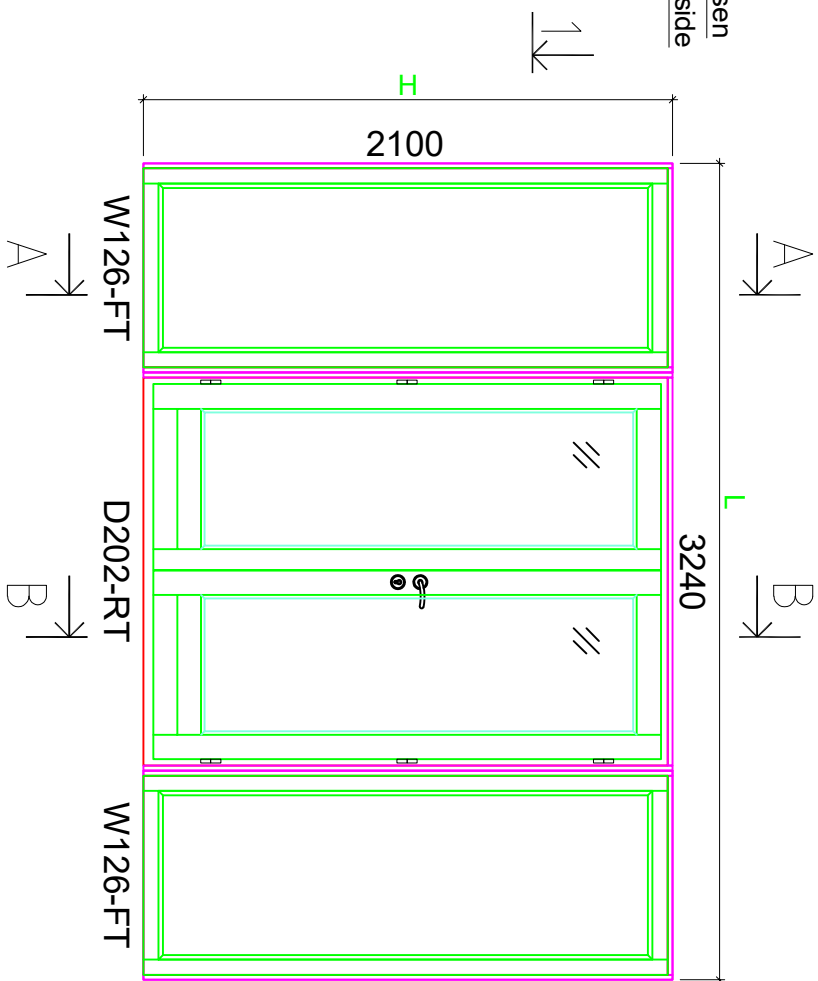

A-A

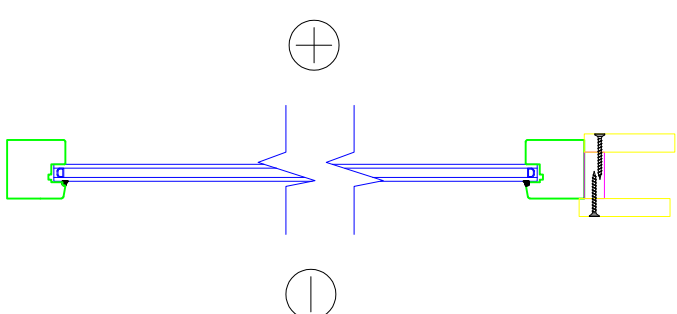

B-B

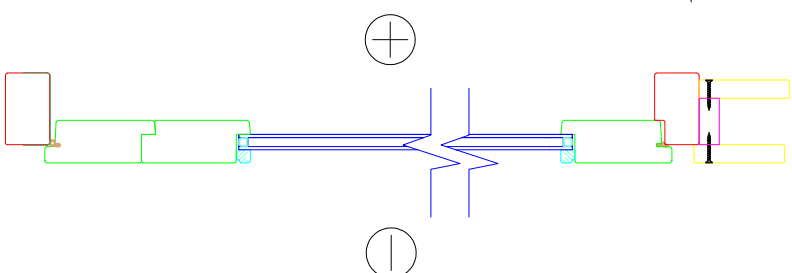

1-1

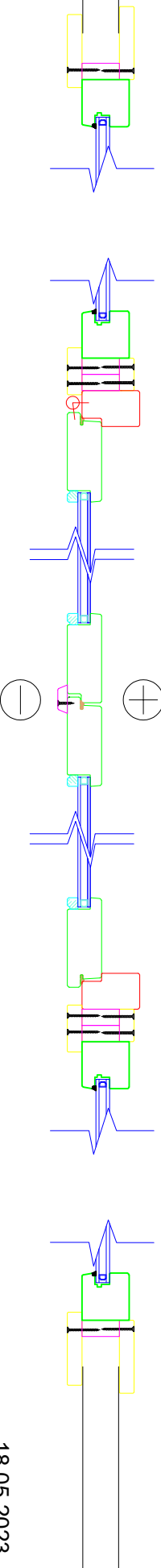

Aken	Q4-Q6	-	paigaldusjuhhis
Window	Q4-Q6	-	assembly instructions
Fenster	Q4-Q6	-	Montageanleitung

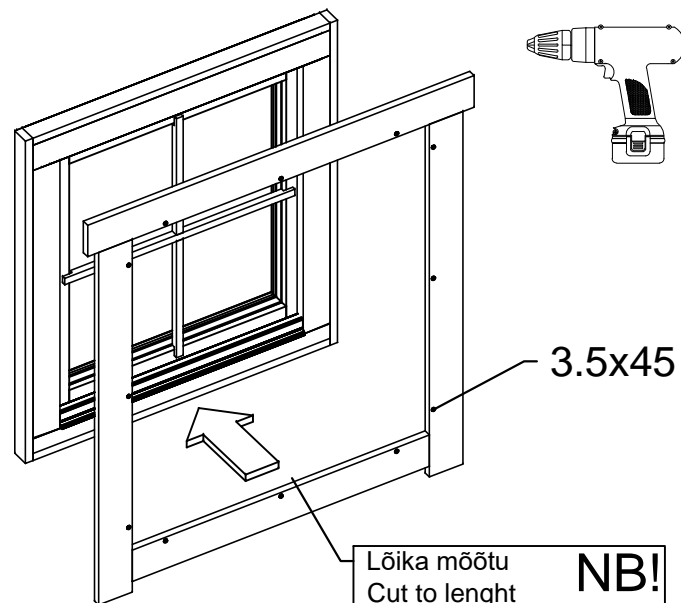
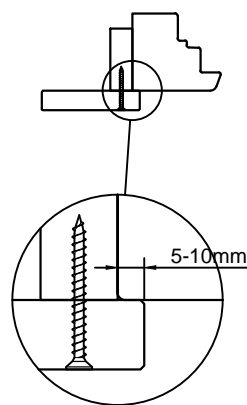
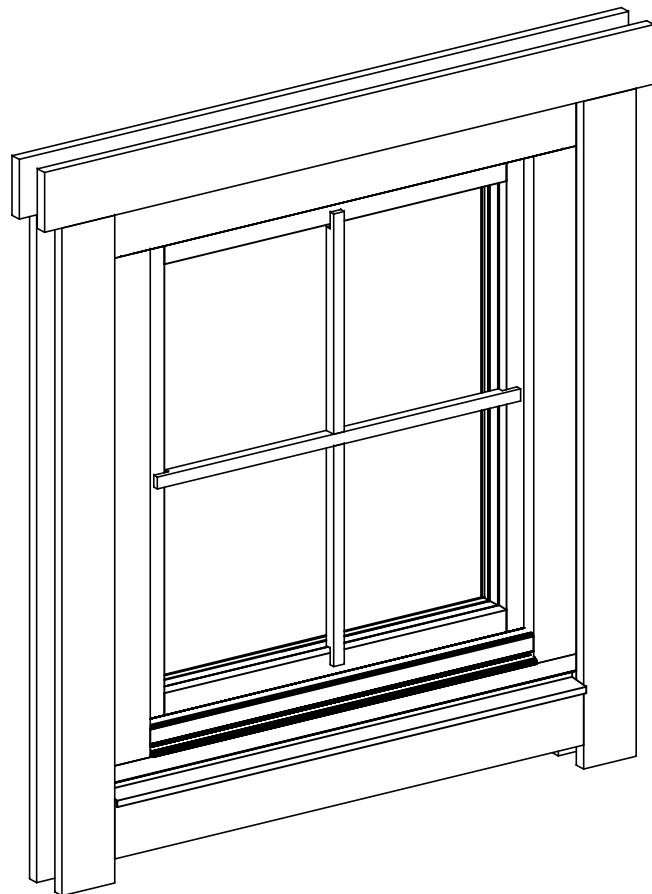

Lõika mõõtu
Cut to length
Absägen
- 10mm / -20mm

NB!

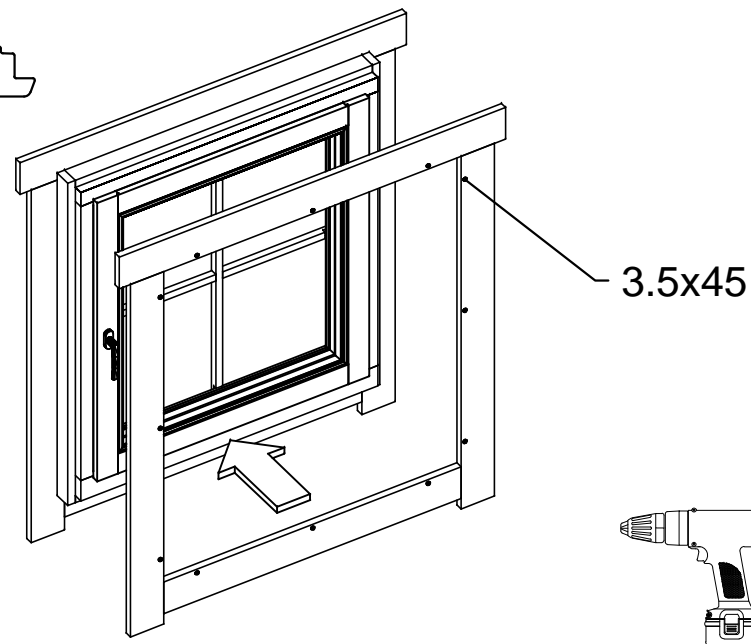
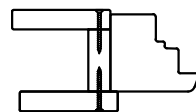

Vihmaliist / Rain strip / Wasserleiste

Q5-Q6

*Silikoon
*Silicon
*Silikon

*Vajumispiilu
*Settling gap
*Senkungs spalt

ca 40-50mm

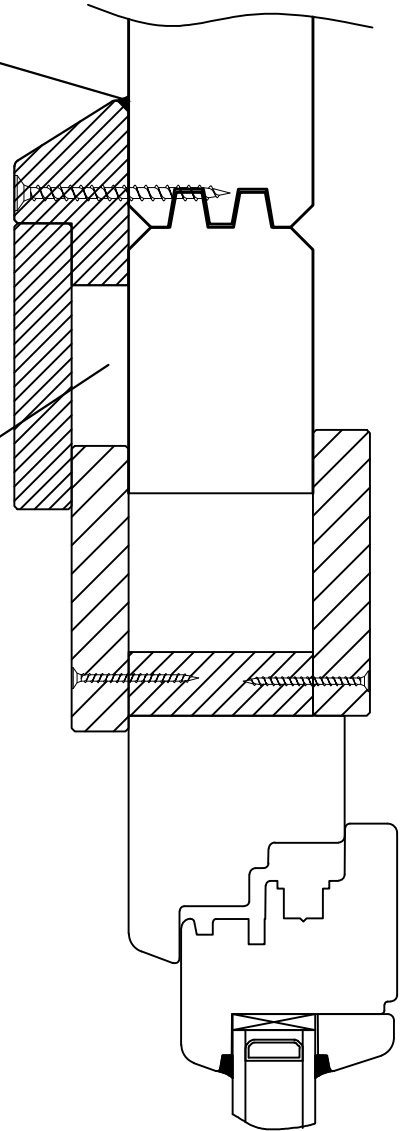
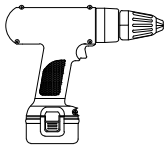

NB!

- Monteerida juhul kui ese on välja toodud maja spetsifikatsioonis!
- Install only if the item is listed in the house specification!
- Nur montieren wenn die Leiste in der Teilleiste gezeigt ist!

Veepilekk / Window sill / Fensterbank

4,2x16

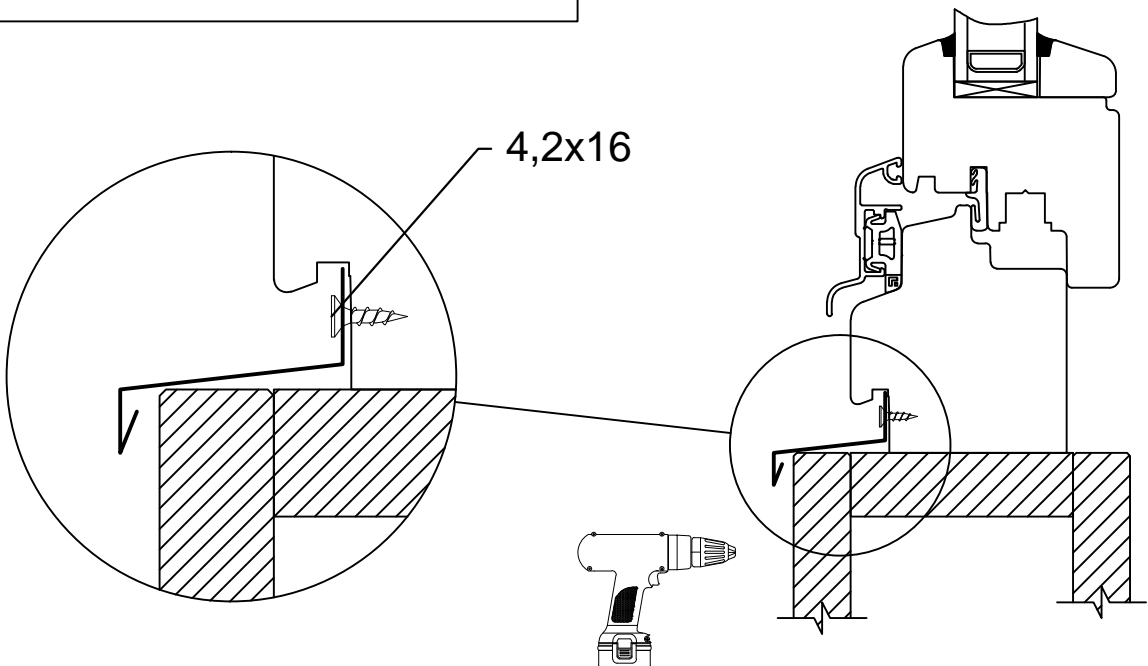

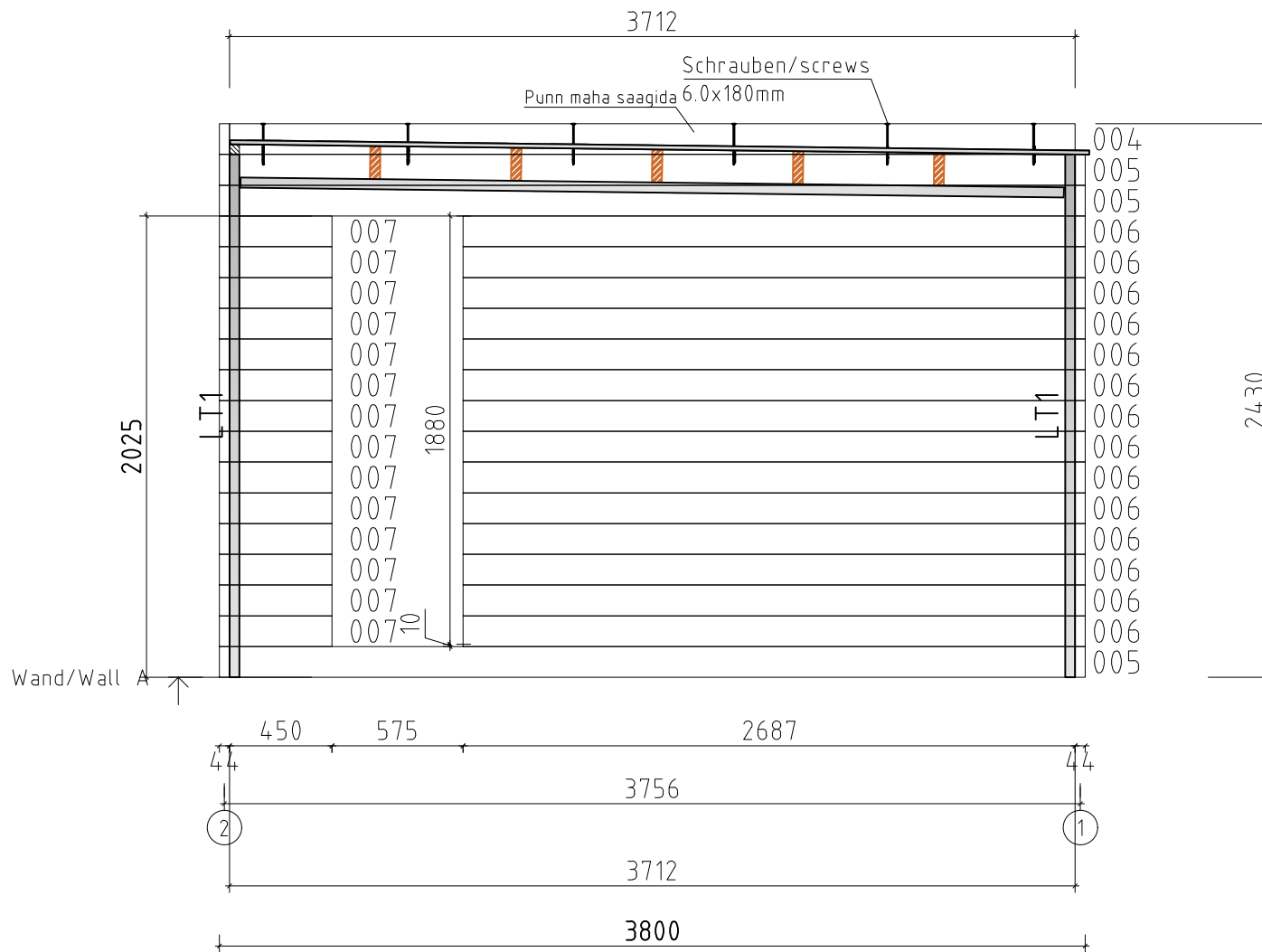

Name	Q - BIC A 380x380; 44		
Zeichnung/Drawing	WAND/WALL A		
Profil/Profile	4.4x13.5	Datum/Date	18.05.2023

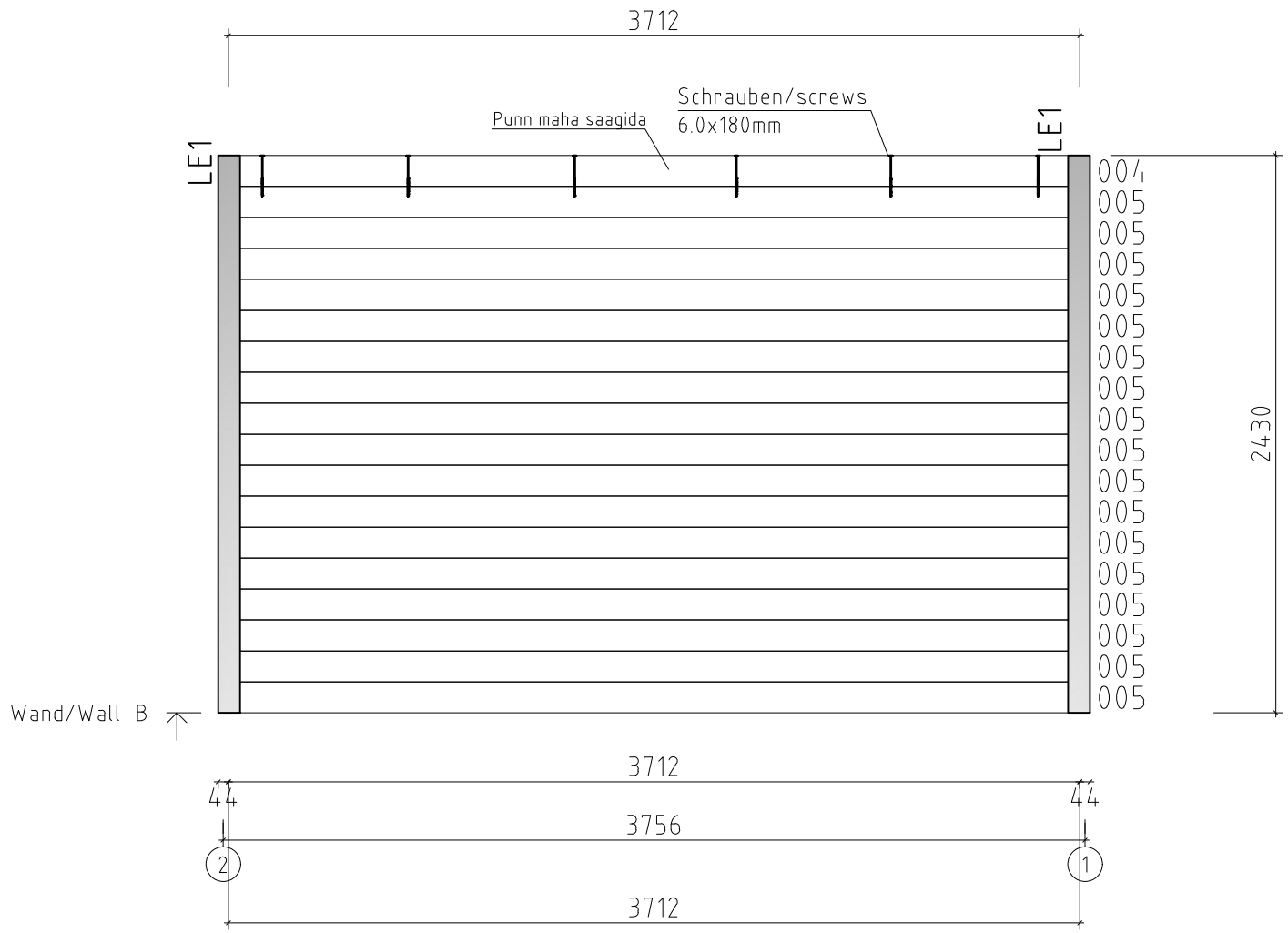

Name	Q - BIC A 380x380; 44		
Zeichnung/Drawing	WAND/WALL B		
Profil/Profile	4.4x13.5	Datum/Date	18.05.2023

