

Donau 28

Art. Nr. 2844199

2844199002 / 2844199003 / 2844199004 / 2844199005

1/7

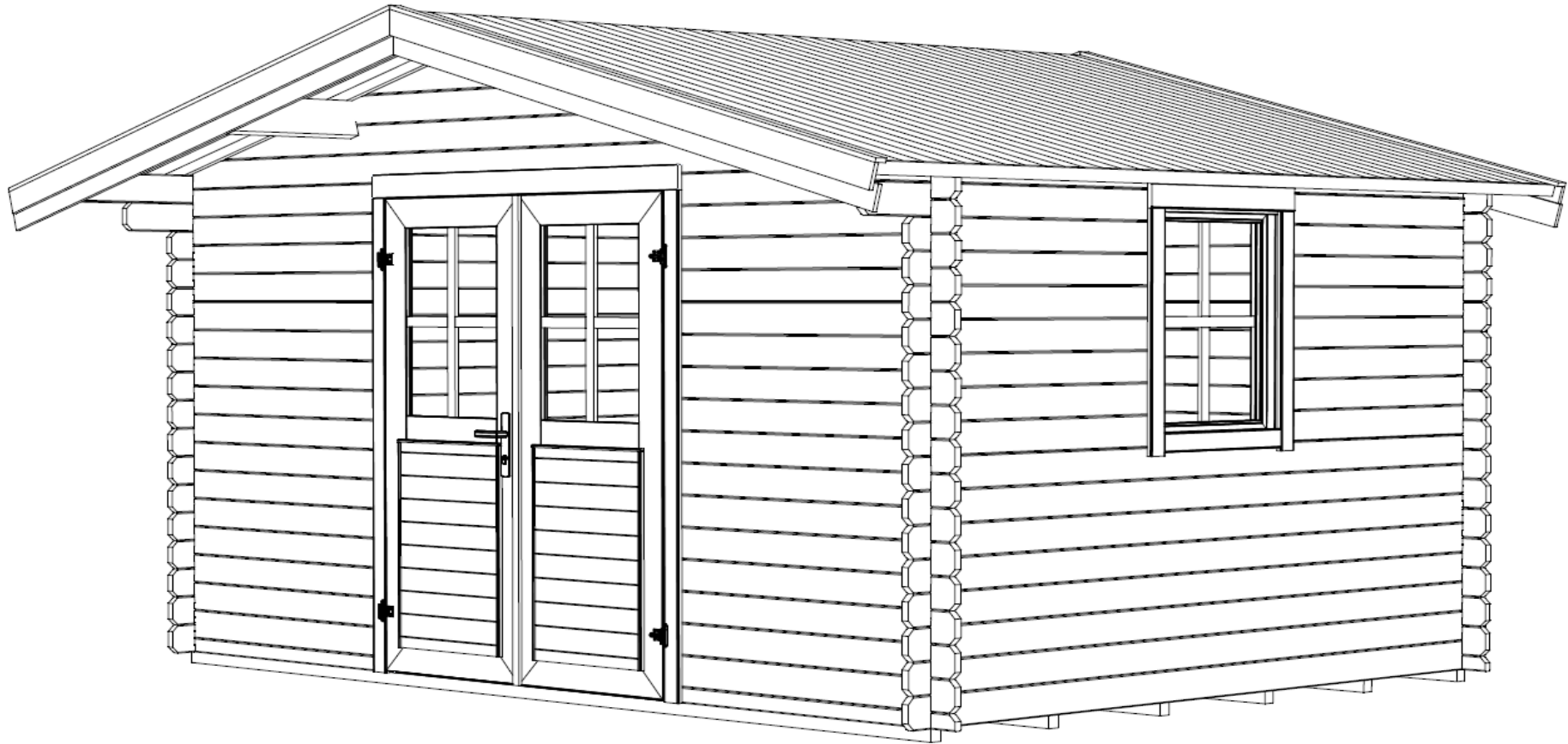

Art. Nr. 2844199

2844199002 / 2844199003 / 2844199004 / 2844199005

Groundplan - Grundplan - Plan de masse - Planimetria - Plattegrond -
Põhiplaan

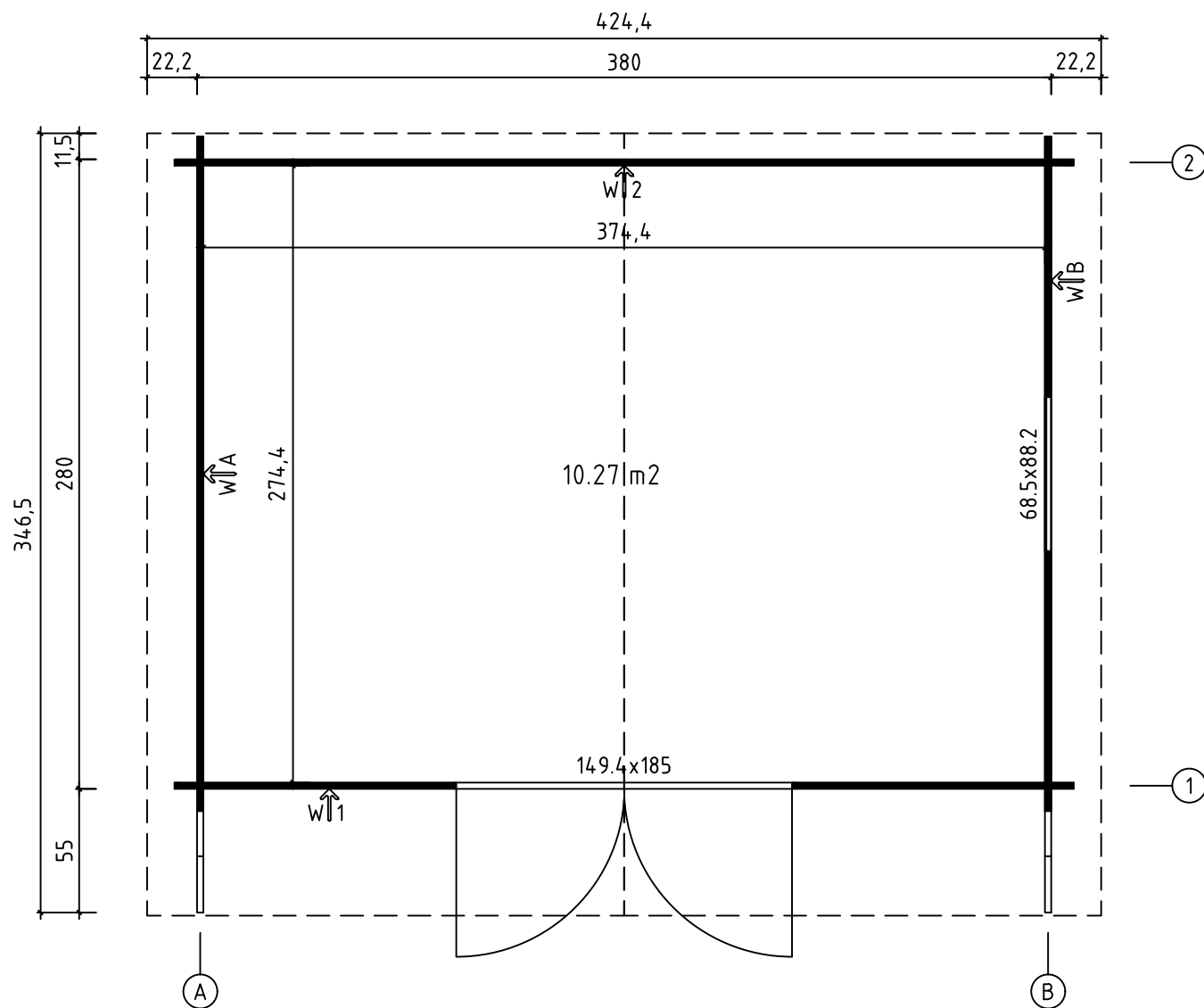

Art. Nr. 2844199

2844199002 / 2844199003 / 2844199004 / 2844199005

Foundation - Fundament - Fondation - Fundamenta - Fundering - Immutatud
alusraam

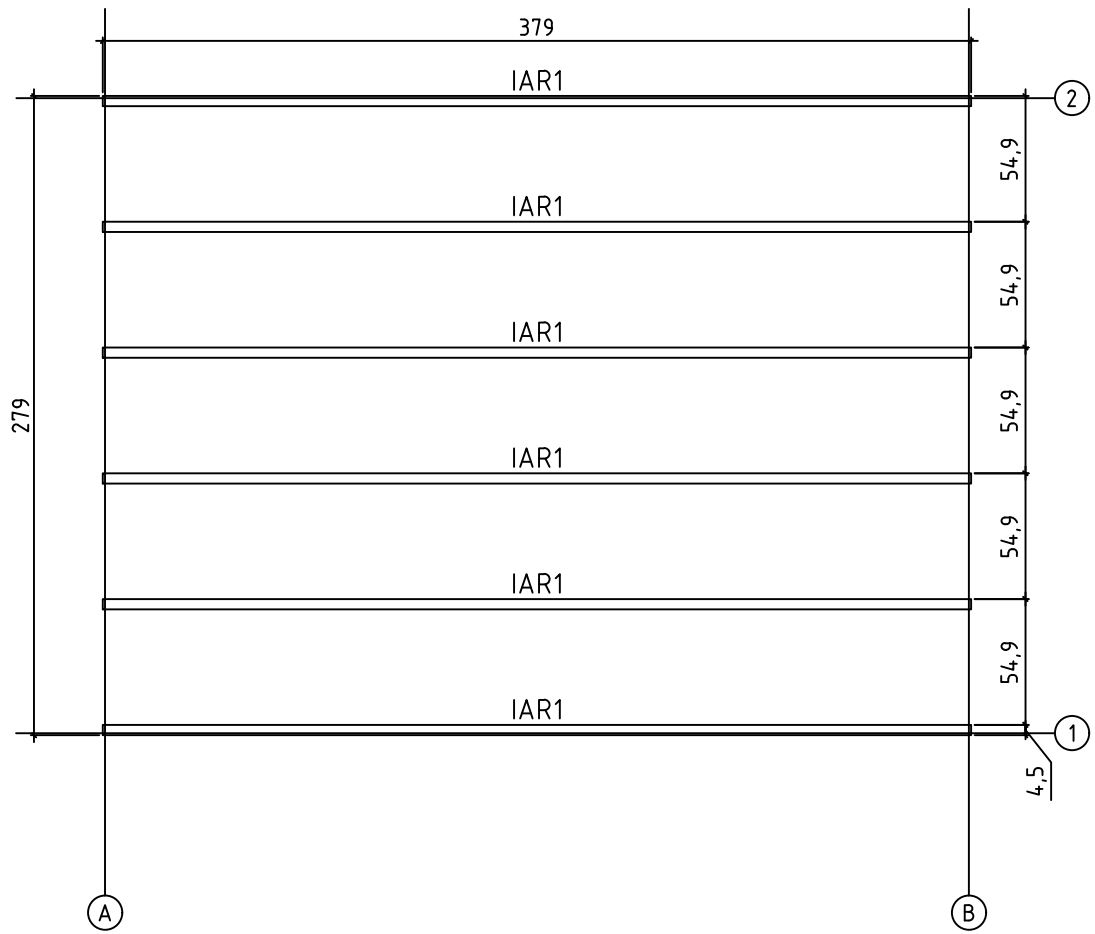

Floor boards - Fussbodenbretter - Plan pose plancher - Pavimento -
Vloerhout - Põrandalaudis

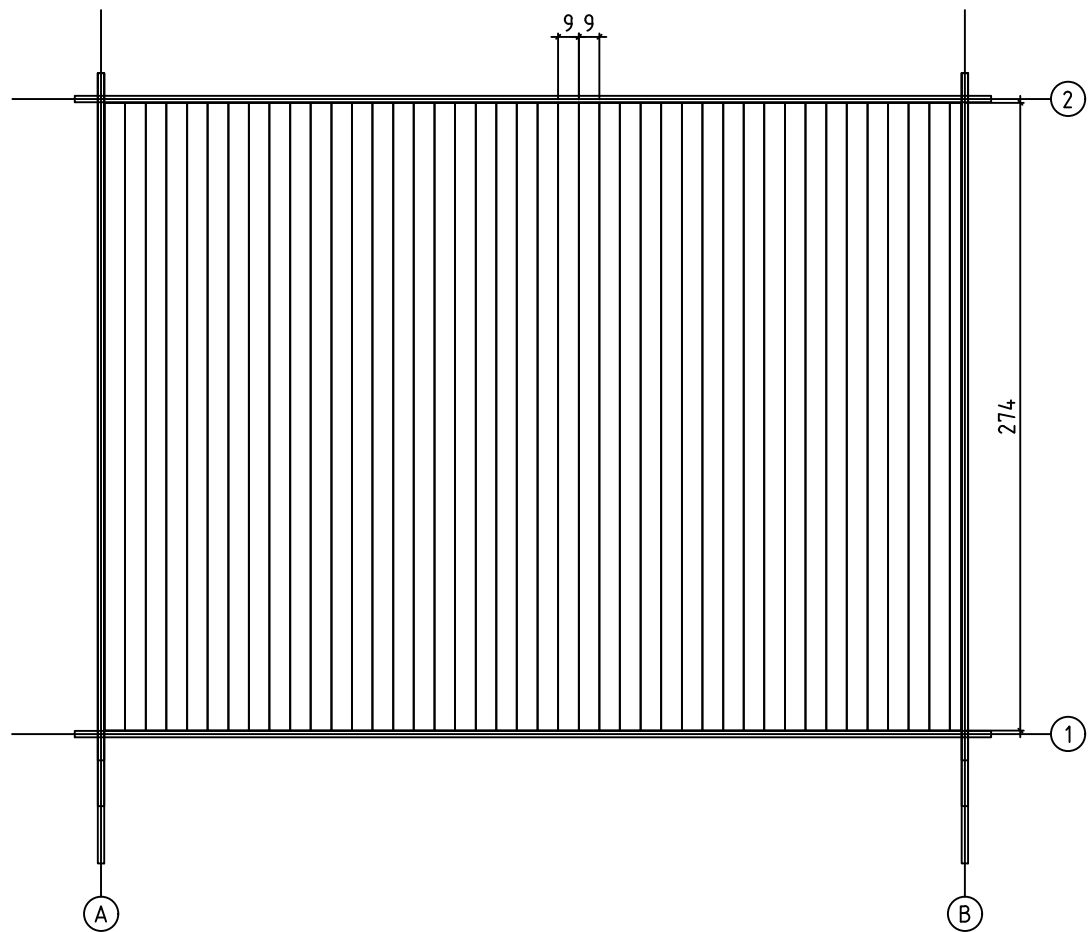

Art. Nr. 2844199

2844199002 / 2844199003 / 2844199004 / 2844199005

Roof plan - Dach-plan - Plan du toit - Piano del tetto - Dak plattegrond - Katuseplan

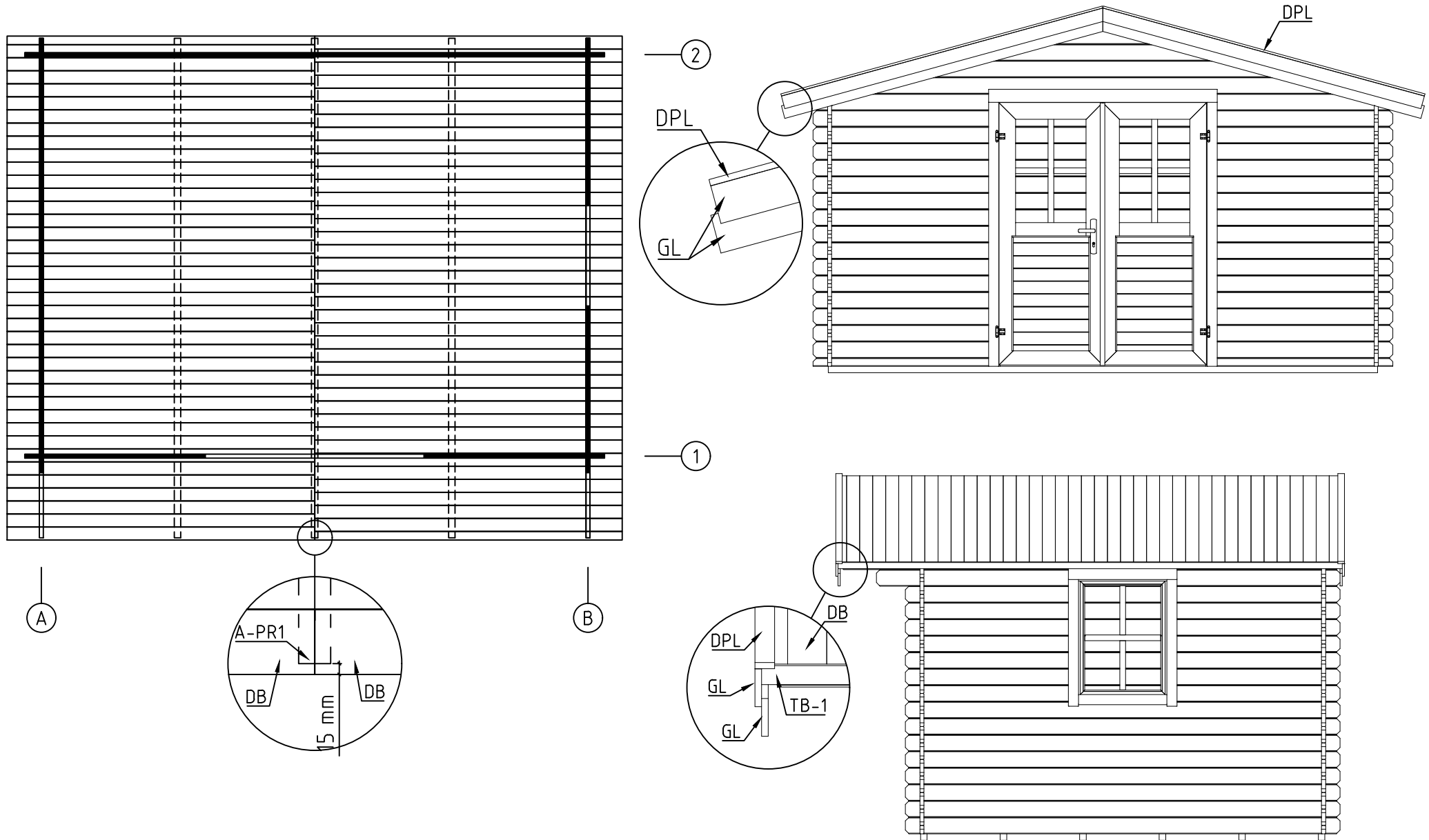



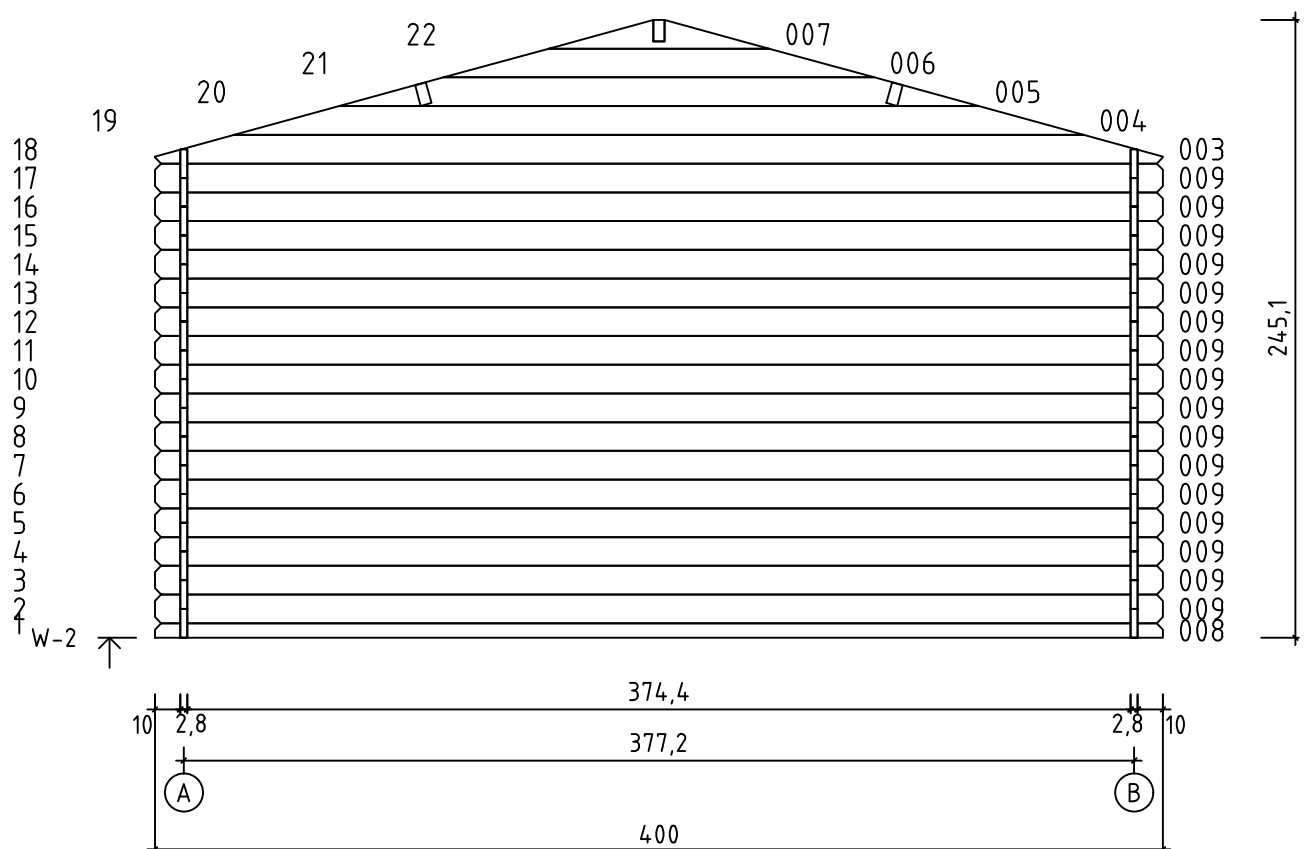
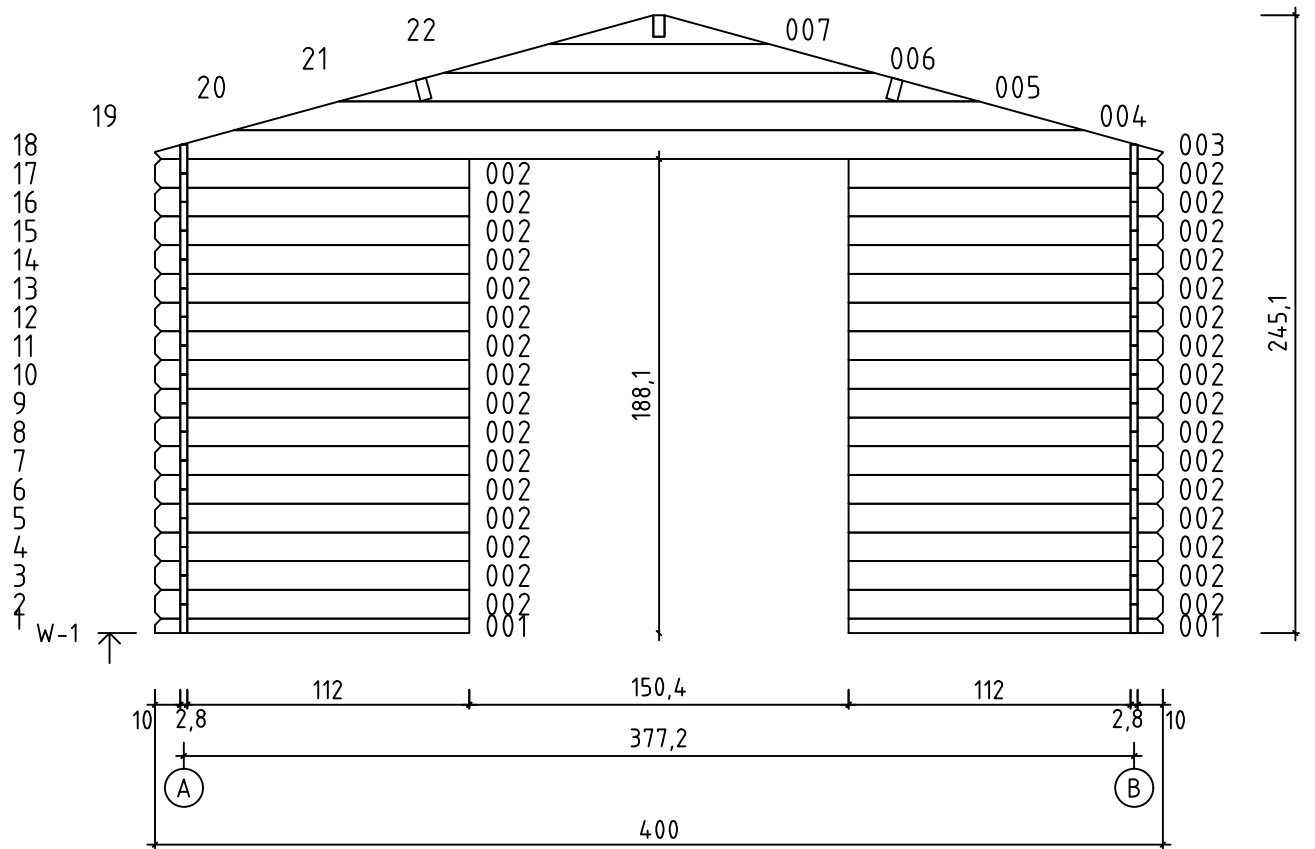

Art. Nr. 2844199
 2844199002 / 2844199003 / 2844199004 / 2844199005



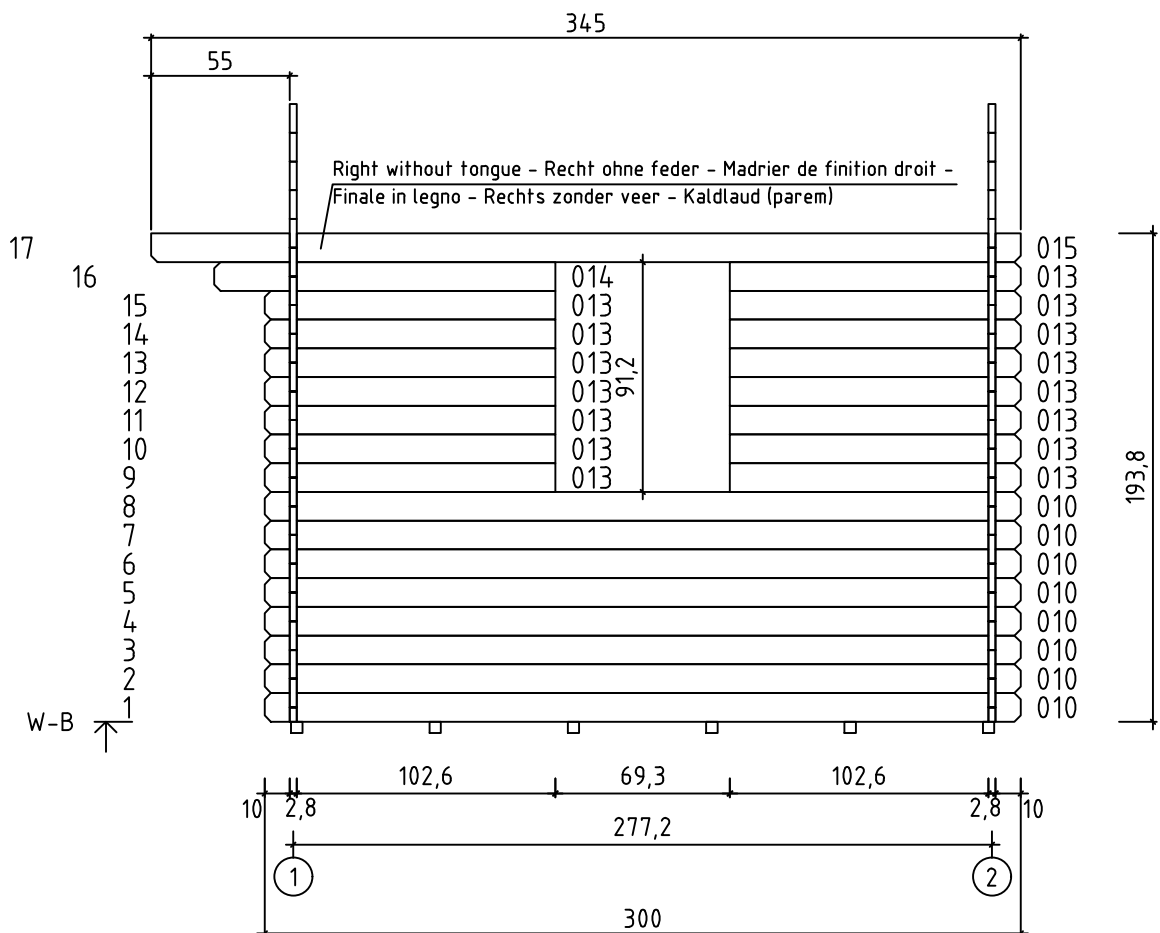
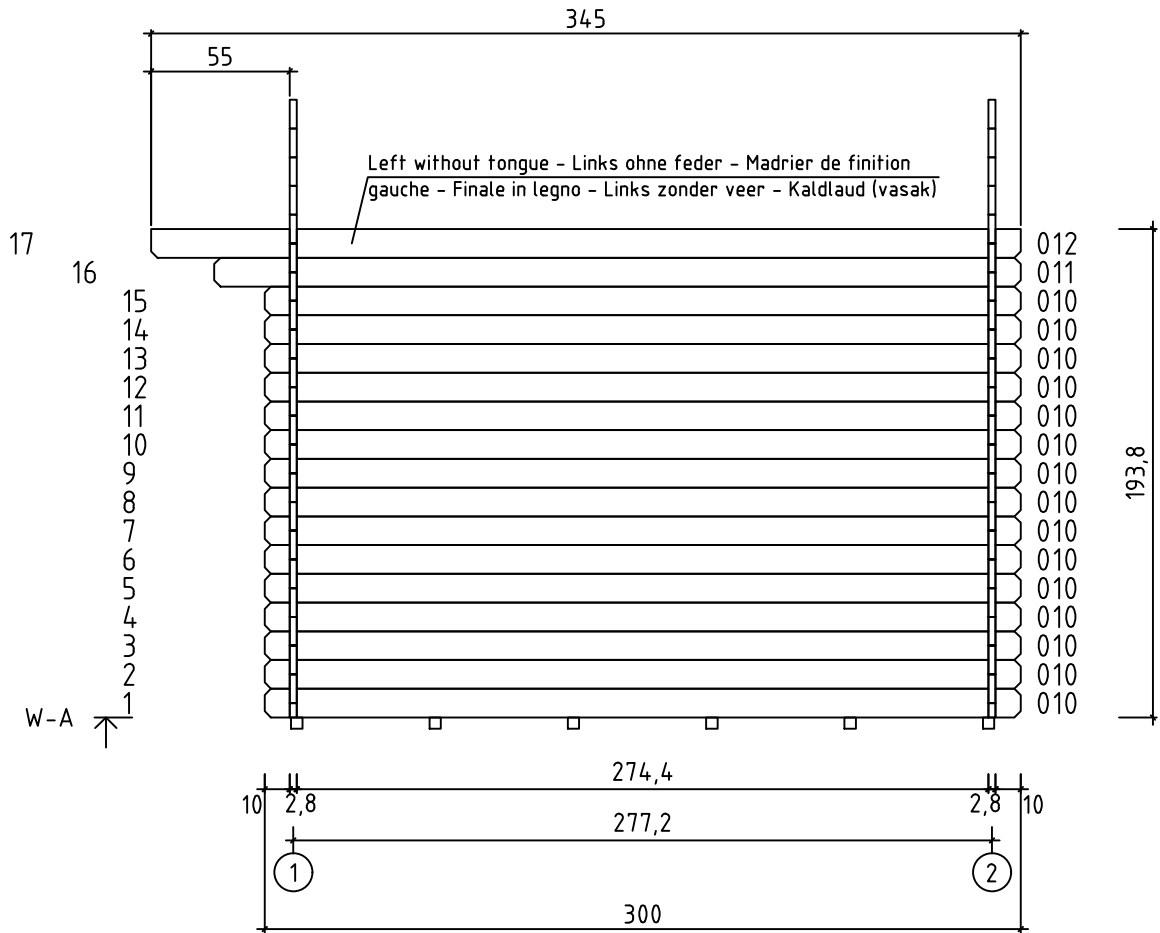

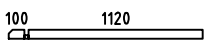
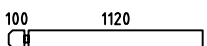
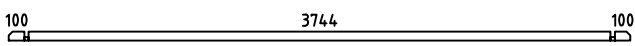
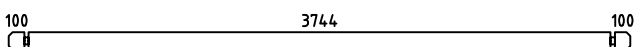
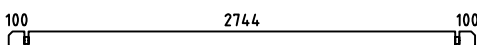
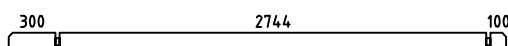
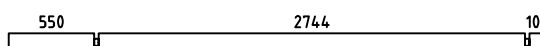
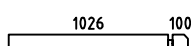
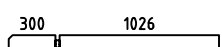
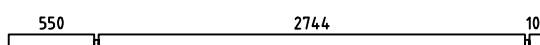
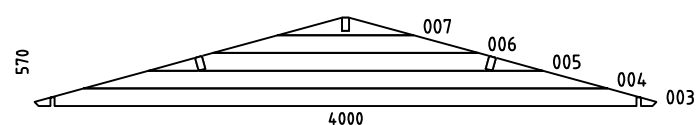
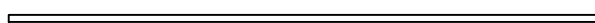
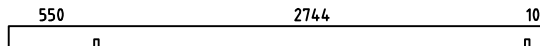
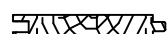

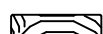
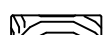
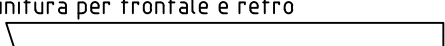

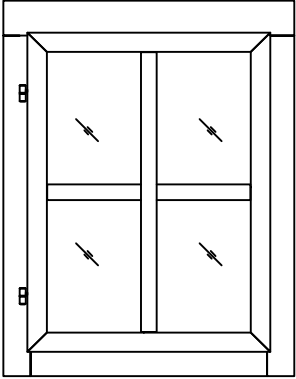
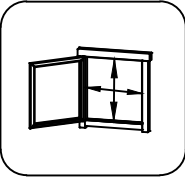
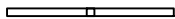
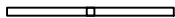

Art. Nr. 2844199

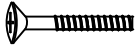
2844199002 / 2844199003 / 2844199004 / 2844199005

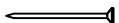
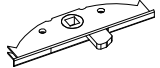

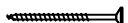
Pos	Piece list - Stückliste - Liste des pièces - Elementi - Stuklijst - Tükitalabel 11.10.2018 Art. Nr. 2844199 2844199002 / 2844199003 / 2844199004 / 2844199005	7/7	Q	P (mm)	L (mm)
001			2	28x57	1248
002			32	28x114	1248
008			1	28x57	4000
009			16	28x114	4000
010			23	28x114	3000
011			1	28x114	3200
012			1	28x120	3450
013			15	28x114	1154
014			1	28x114	1354
015			1	28x120	3450
W1-1 W2-1			1 1		
IAR1	Foundation - Fundament - Fondation - Fondamenta - Fundering - Immutatud alusraam 		6	45x45	3790
A-PR1	Roof beam - Dachbalken - Panne de toit - Perlina del tetto - Gordingen / dakbalk - Pärilin 		3	44x140	3450
	Floor boards - Fussbodenbretter - Lame de plancher - Pavimento - Vloerhout - Põrandalaud 		42	90x15	2740
DB	Roof boards - Dachbretter - Voliges - Perlina per tetto - Dakhout - Katuselaud 		78	90x15	2200
	Floor fillet - Fussbodenleiste - Corniere de finition du plancher - Finitura per pavimento (battisco pa) - Vloerafwerkljst - Põrandaliist 			18x18	12.96
DPL	Roofing felt fillet - Dachpappenleiste - Baguette de fixation du feutre bitumeux - Asse per fissaggio guaina bituminosa - Afdekljst asfaltpapier - Katusepapiilist 		4	15x45	2250
TB-1	Fascia board - Traufbrett - Bandeau de toit - Finitura lati tetto - Gevellijst - Räästalaud 		2	15x45	3480
GL	Gable moulding - Giebelleiste - Planche de rive - Finitura per frontale e retro del tetto - Gevellijst - Viilulaud 		8	15x90	2250
SH28	Hammer block - Schlagholz - Calle de frappe - Blocco di legno da usare come cuscinetto quando si usa il martello - Slagklos - Löögiklots 		1		
	Window - Fenster - Fenetre - Finestra - Raam - Aken 685x882 AK.1.104.SVV.Pf SGA+E		1		
	Door - Tür - Porte - Porte - Deur - Uks 1494x1850 TUK.2.054.SVV.MMXT28a SGA+28E		1		

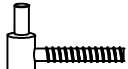
Pos	04.10.2018	Piece list - Stückliste - Liste des pièces - Elementi - Stuklijst - Tükítabel 685x882 AK.1.104.SVV.Pf SGA+E	1/1	Q	P (mm)	L (mm)
		Glass size - Glasgröße - Taille de la vitre - Misura del vetro - Glas afmeting - Klaasi mõõt: 542x738 mm			541x738	
1	Georgian bars - Sprossen - Croisillons - La griglia georgiana - Raamverdeling - Petteliistud		1	15x40	720	
2	Georgian bars - Sprossen - Croisillons - La griglia georgiana - Raamverdeling - Petteliistud		1	15x40	524	
FS1	Window handle fittings - Fenstergriff - Poignée de fenetre - Maniglia c/ferramenta - Raamhendel -/grendel -/klink - Aknalink		1			
FSP	Bolt for window handle fittings - Bolzen für fenstergriff beschlag - Vis pour fixation poignée de fenetre - Bullone x apertura manuale finestra - Schroef voor raamhendel - Akna käepideme polt		2			
	Window/door cross slot straight (plastic) - Fenster/türen einsewaren - Quincaillerie pour portes et fenetres - Traversa diritta in plastica per finestra o porta - Ramen / deur kruis (rechte sleuf kunststof) - Liistu ristriiv		4			
NF1	Nail for window/door cross slot straight - Nägel für fenster/türen einsewaren - Pointe pour quincaillerie pour portes et fenetres - Chiodo per scanalatura finestra o porta - Schroef voor deur / raamkruisslot (recht) - Liistunael ristriivile		8	1.4x30		
FSL	Window closer - Fenstergriff - Système de fermeture pour fenètre - Serratura della finestra - Raamslotje - Akna sulguri südamik		1			
FSA	Window closer striker - Gegenstück für Fenstergriff - Entrebâilleur de fenètre - Attacco aggancio per serratura della finestra - Raam sluitplaatje - Akna luku vastus		1			
HS31	Screw for window closer striker - Schraube für Gegenstück / Fenstergriff - Vis pour entrebâilleur de fenètre - viti per attacco della serratura della finestra - Schroef voor raam sluitplaatje - Kruvi akna luku vastusele		2	3.5x15		
NA7	Hinge for window - Scharnier für fenster - Charniere pour fenetre - Cerniere per Finestra - Raam scharnier - Aknahing		2			
NA8	Hinge for window - Scharnier für fenster - Charniere pour fenetre - Cerniere per Finestra - Raam scharnier - Aknahing		2			

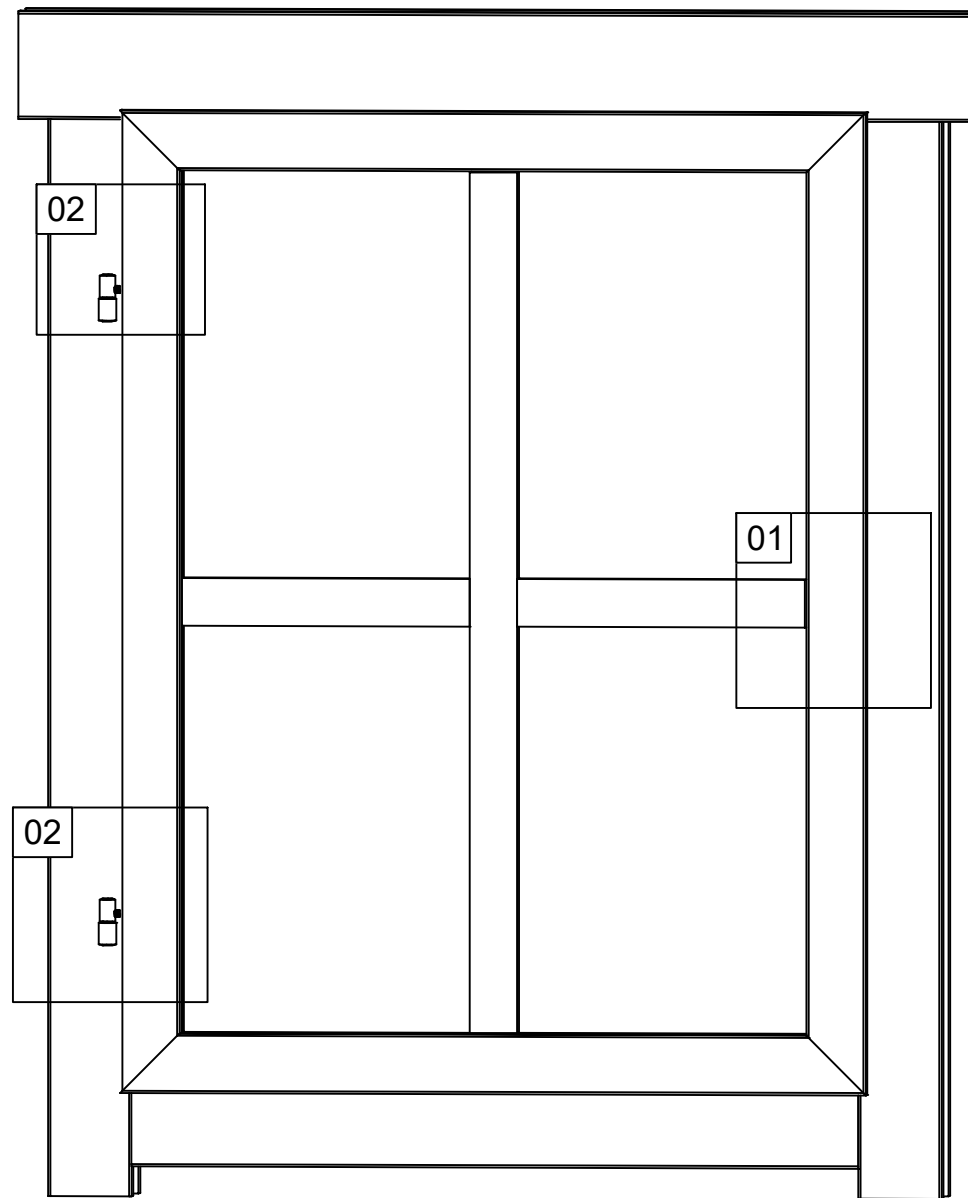
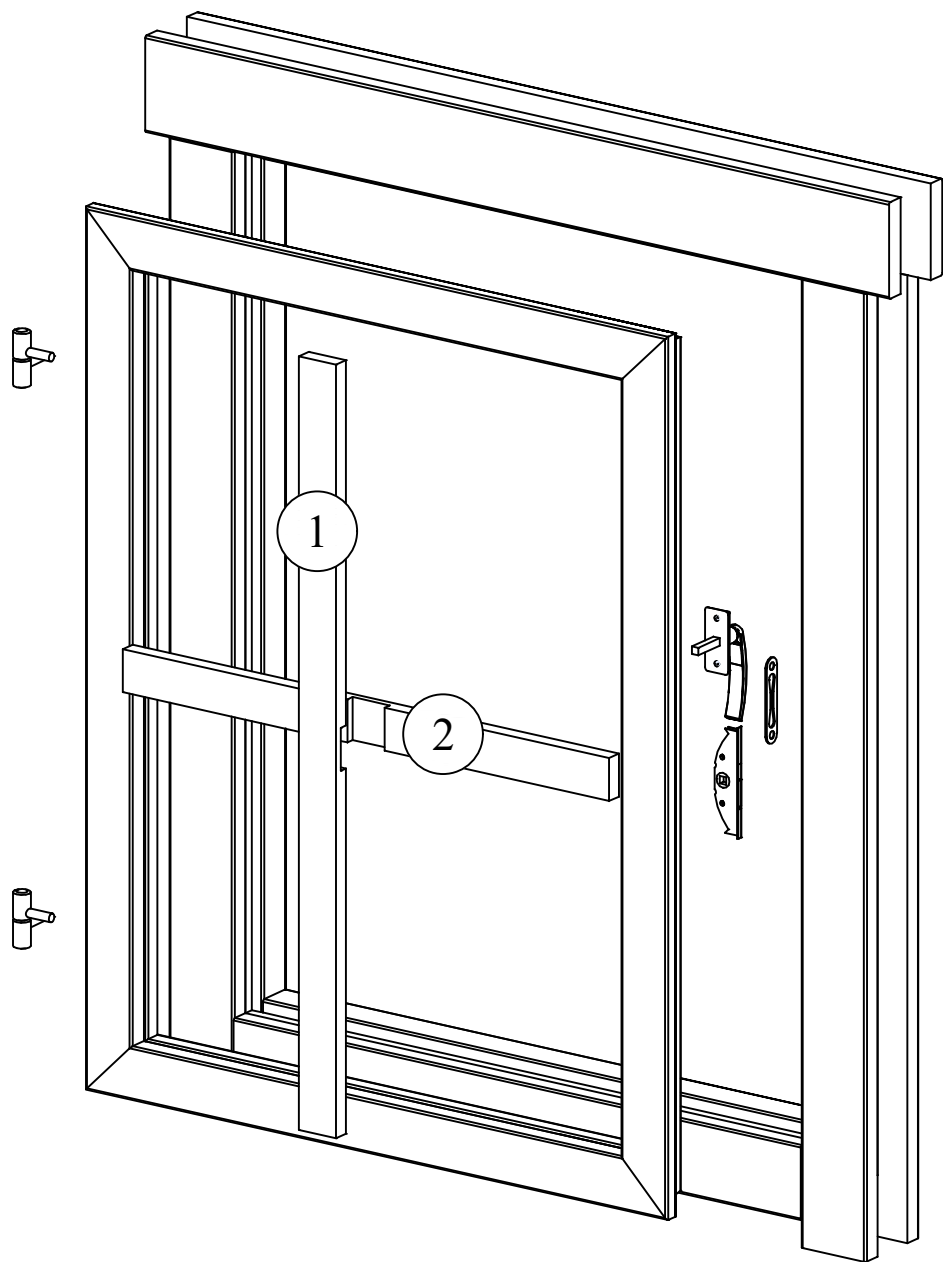

01

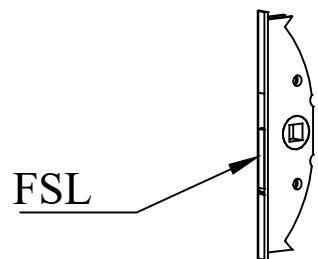

FSL

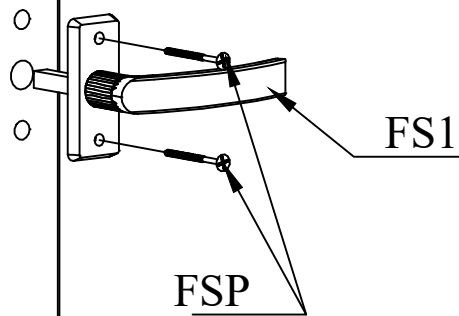

FS1

FSP

02

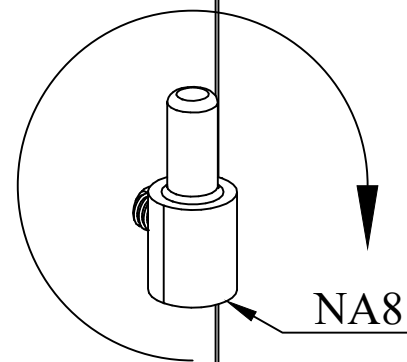

NA8

01

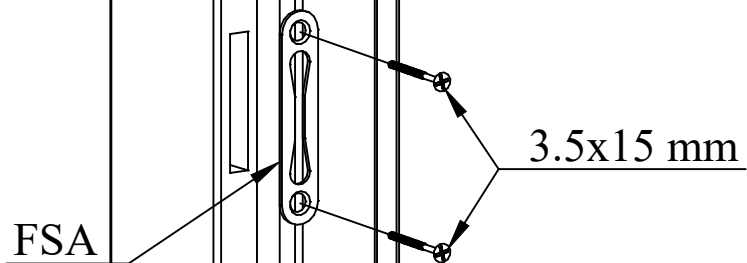





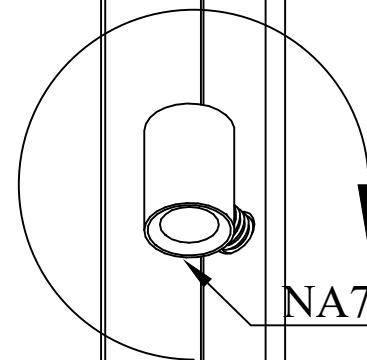

FSA

3.5x15 mm

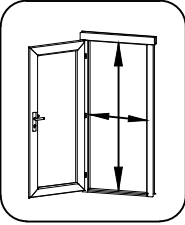
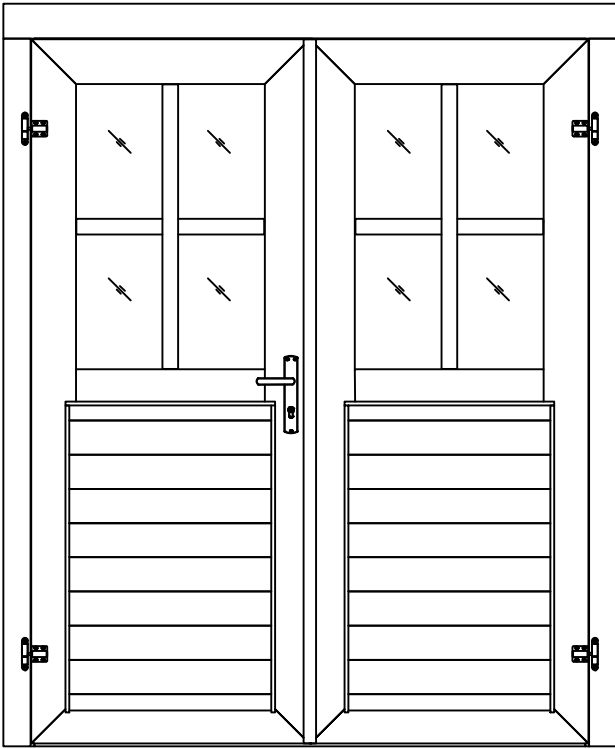
02

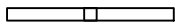

NA7

Pos	03.10.2018	Piece list - Stückliste - Liste des pièces - Elementi - Stuklijst - Tükítabel 14 94x1850 TUK.2.054.SVV.MMXTP28a SGA+28E	1/2	Q	P (mm)	L (mm)	
	Glass size - Glasgröße - Taille de la vitre - Misura del vetro - Glas afmeting - Klaasi mõõt: 502x750 mm				 1418x1794 mm		
							
1	Upper door jamb - Türrahmen oben - Cadre de porte supérieur - Telaio superiore della porta - Bovendorpel - Ukse ülemine leng				1	66x100	1628
2	Left door jamb - Türrahmen links - Cadre de porte gauche - Telaio montante sinistro della porta - Linkerstijl deurframe - Ukse vasak leng				1	66x80	1850
3	Right door jamb - Türrahmen rechts - Cadre de porte droit - Telaio montante destro della porta - Rechterstijl deurframe - Ukse parem leng				1	66x80	1850
4	Doorstep - Swelle - Barre de seuil - Soglia della porta - Deurdorpel - Lävepakk				1	18x18	1418
5	Connection strip - Deckleiste - Baguette de battement - Profilo verticale della porta - Stulplijst - Kokkuvältsiliist				1	13x32	1812
6	Georgian bars - Sprossen - Croisillons - La griglia georgiana - Raamverdeling - Petteliistud				2	15x40	732
7	Georgian bars - Sprossen - Croisillons - La griglia georgiana - Raamverdeling - Petteliistud				2	15x40	484

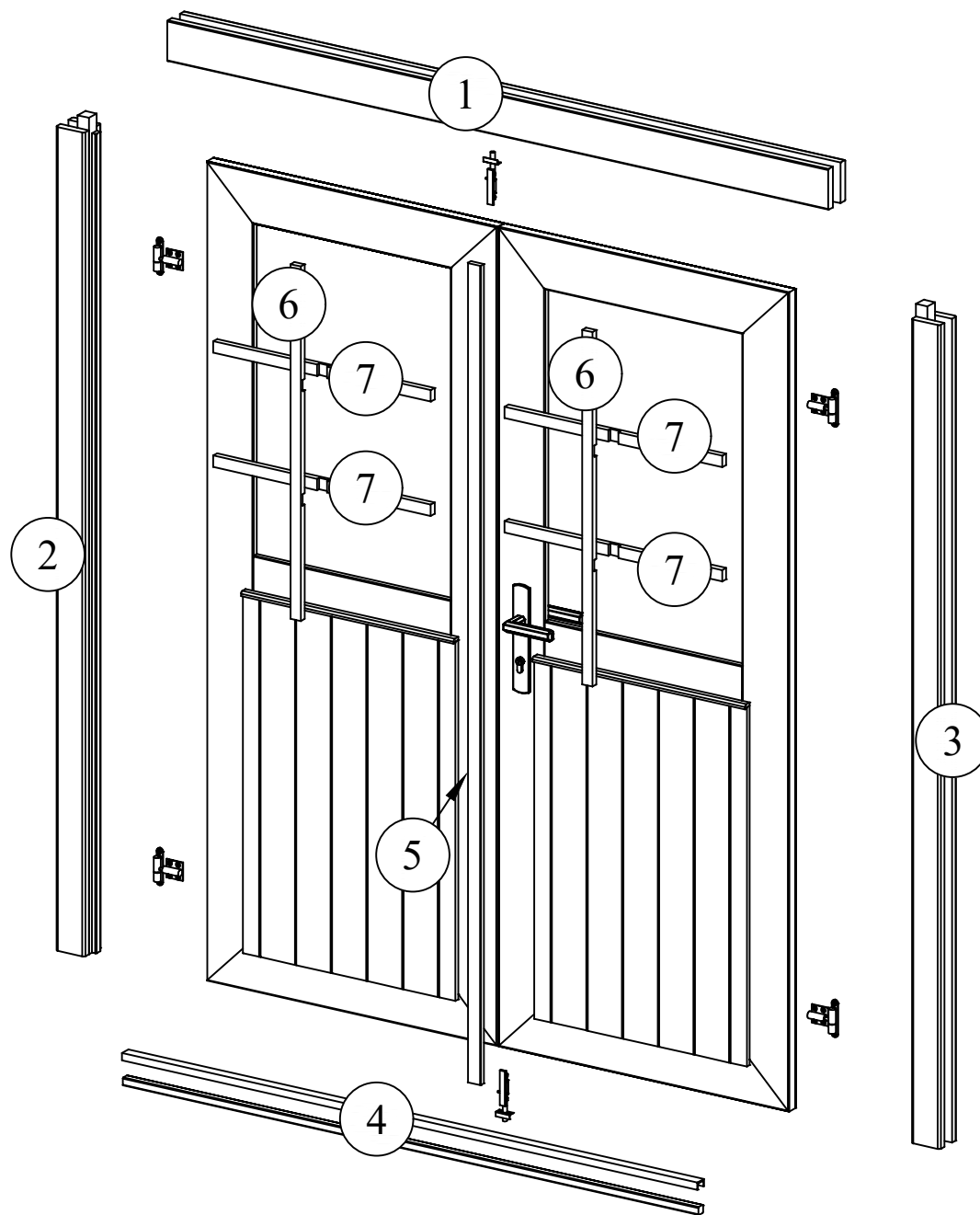

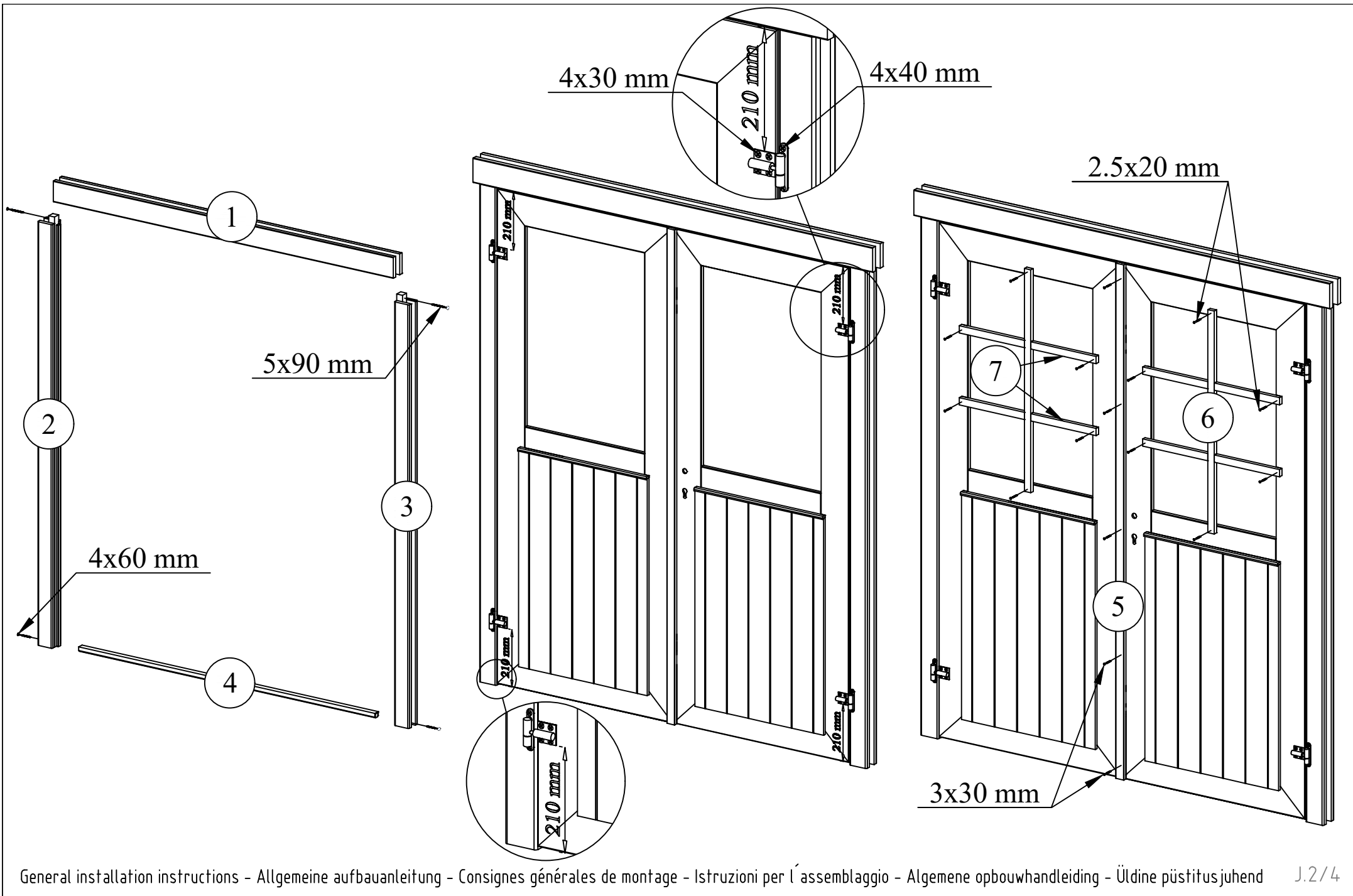

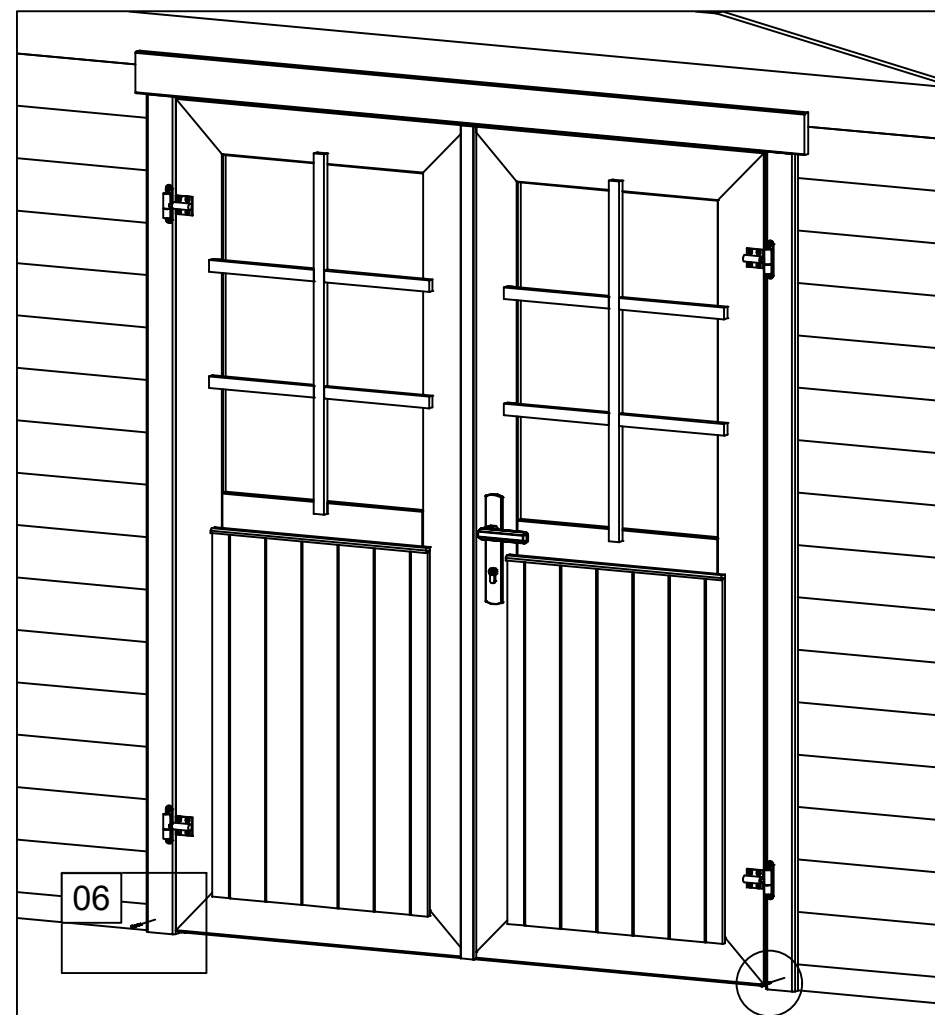
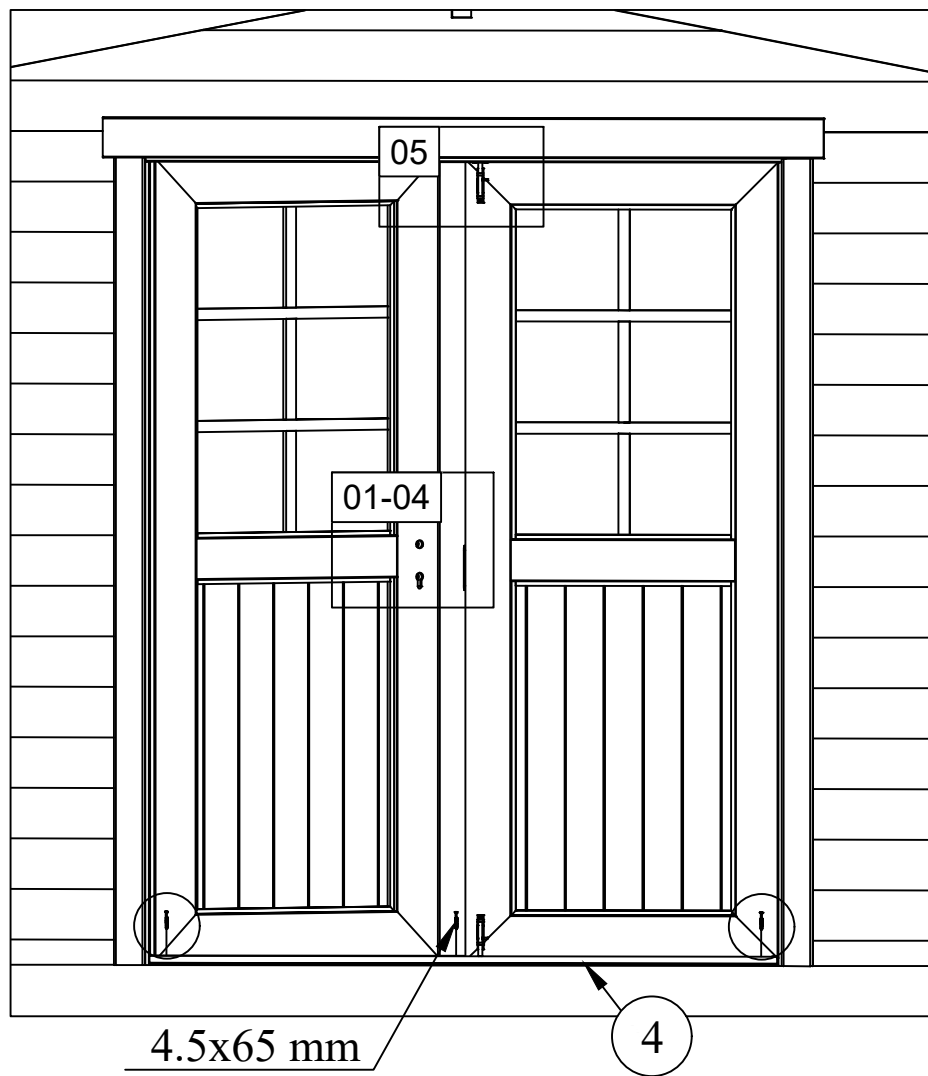

01

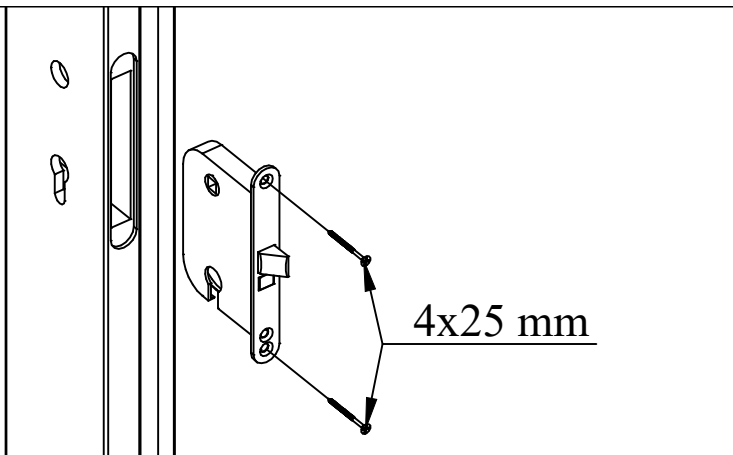

04

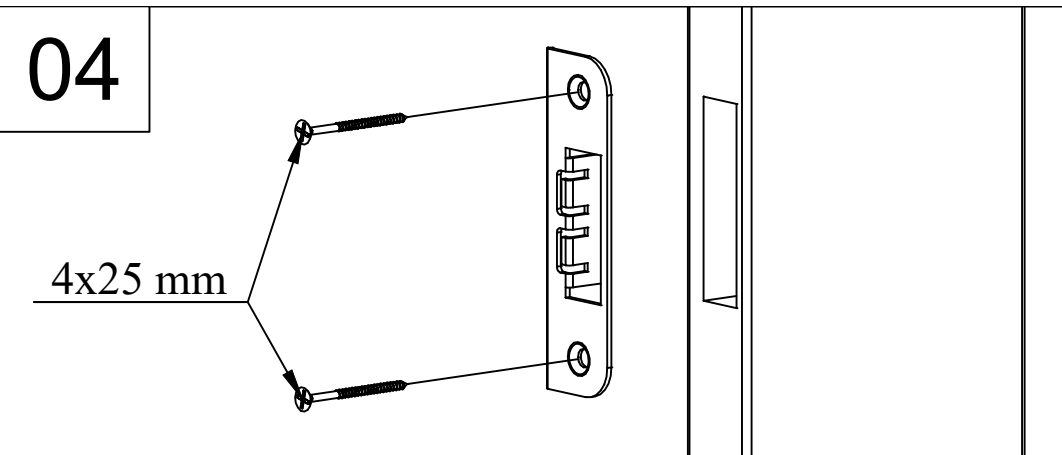

02

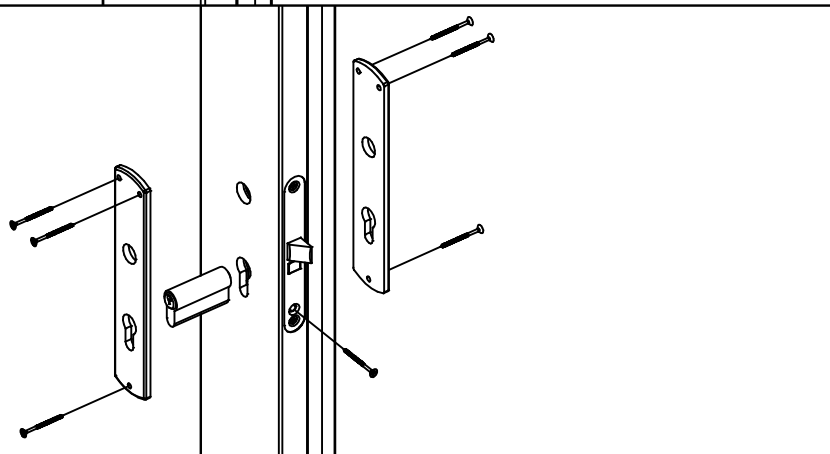

05

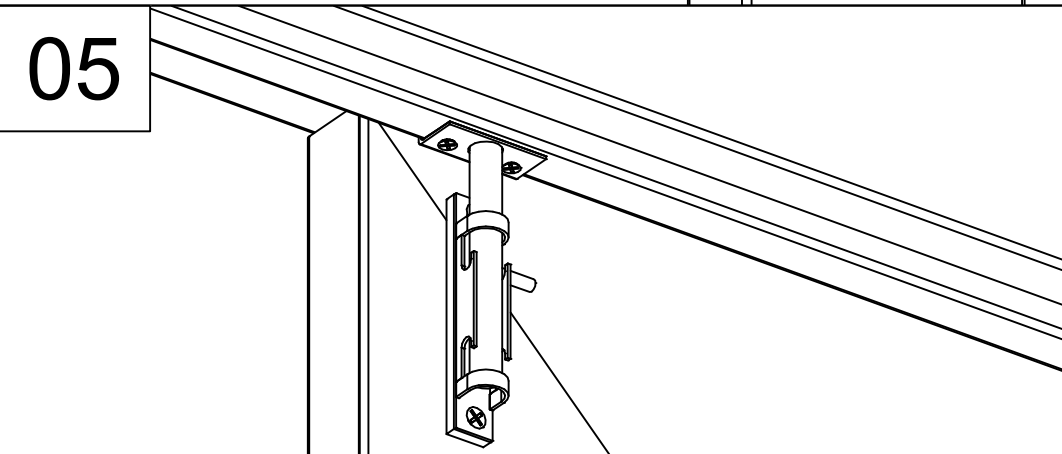

03

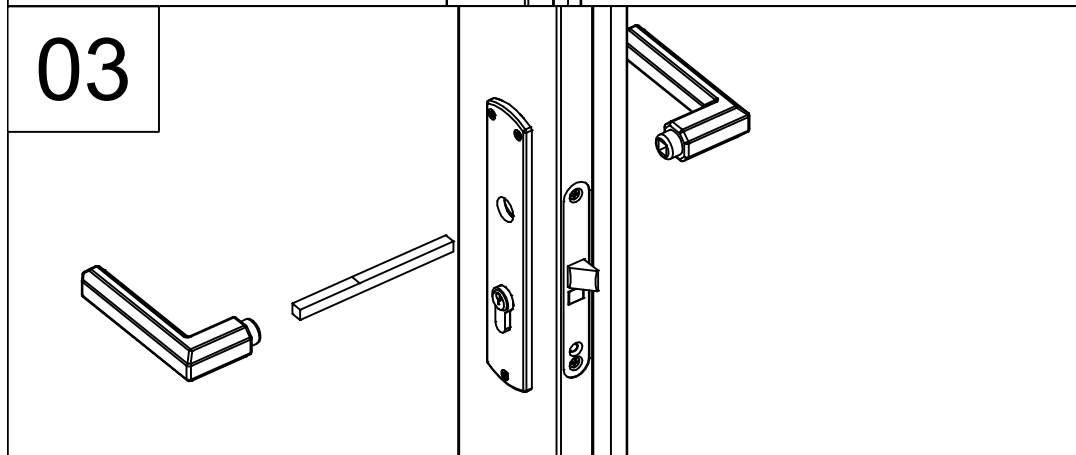

06

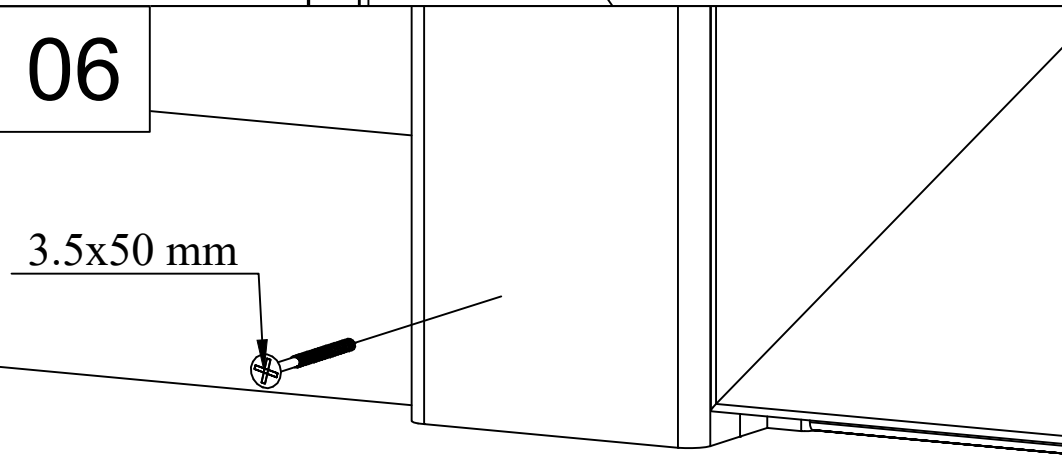

+E

